

# Moray Hydrogen Strategy

Report

May 2022



# Executive Summary

Moray Council has a commitment to become Carbon Neutral by 2030 and to provide the necessary leadership to local business and communities to assist in the Moray wide transition to net zero by 2045. The Council approved a Climate Change Strategy on 10th March 2021 with a high-level action plan.

Moray has a population circa 97,000 and has high levels of manufacturing including 50% of Scotland's distilleries and global brands.

Hydrogen is fast becoming a key energy resource in the transition to a low carbon future. To achieve Moray Council's commitment to be Carbon Neutral by 2030 and enable the energy transition, the Council has engaged Mott MacDonald to develop a strategy for Hydrogen, including opportunities for the transition of Council owned buildings and the transport fleet.

Highlands and Islands Enterprise (HIE) also sought for the strategy to include information on the decarbonisation of Moray's distilling industry and other key hydrogen projects; and the associated infrastructure requirements to produce, store and supply hydrogen.

Developing a Hydrogen economy in Moray during the short to medium term, including connecting into adjacent areas, could contribute to a reduction in greenhouse gases and particulate emissions, improve security of energy supply, contribute towards the decarbonisation of transport, increase and make better use of renewable energy generation, and could help address fuel poverty issues, particularly in rural areas.



Moray Council and HIE wants to create a Hydrogen economy to achieve the benefits by developing a Hydrogen Strategy and Action Plan which explores the use of green Hydrogen to help achieve this. The Council recognises that Hydrogen could have a key role in providing an alternative energy to fossil fuels.

The challenge is to understand the market context within Moray to develop short-, medium- and long-term hydrogen demand profiles which can then be used to determine the viability of hydrogen generation and storage.

# 2045

Moray to transition to net zero

# 2030

## Moray Councils carbon neutral target

The development of a hydrogen economy within Moray will bring many benefits to the region including inward investment, creation of new opportunities and jobs, retention and development of young persons in Moray. Inward investment in the hydrogen supply, demand and infrastructure within Moray offers a sustainable economic growth opportunity with a positive impact on reducing poverty.

Developing a hydrogen economy to meet the Scottish Government's and Moray Council's net zero target of 2045 and the Council's 2030 carbon neutral target will require the parallel growth of supply and demand. The Hydrogen Strategy for Moray sets out how the supply for hydrogen can be increased over time to meet the increasing local demand for hydrogen from industrial users, transport, hospitals, and public sector organisations as well as local communities.



Moray has access to significant sources of green renewable power including offshore and onshore wind farms which, subject to contract, could create the conditions required to produce green hydrogen within Moray at scale. To deliver a hydrogen economy the following key steps are proposed:

- Create a hydrogen steering group within Moray to drive the development of hydrogen opportunities, stimulating both supply and demand. This group could be led by Moray council and include key stakeholders from the industrial base and wider community.
- Start to generate hydrogen within Moray to generate demand. Small scale pilot projects are proposed to include combined hydrogen generators, storage and refuelling at a single site. The potential sites to be developed include Lossiemouth, Aberlour, Buckie Harbour and Elgin. The target users for the hydrogen in the first instance would be the “back to base” and transport fleets such as local buses and refuse trucks.
- Expand the hydrogen generation facilities to further stimulate the demand from road freight transport and form the industrial users such as the distilleries. Hydrogen can start to be distributed by road tanker from the generator to the end user. A network of hydrogen refuelling stations can be developed, further stimulating demand from the road freight transport users.
- In the long term, the hydrogen economy for Moray could be based on generating hydrogen from green electricity sources within Moray, purchasing hydrogen from outside the area, and distributing hydrogen through the area through a pipeline network. The demand for hydrogen would come from a wider range of sectors including the distilleries, the road haulage industry, council services and to heat homes and businesses.

# 1. Introduction

Moray is an ideal location to establish a hydrogen economy with direct access to existing and future large scale renewable energy sources, including onshore and offshore wind power, and reliable water sources, providing the essential resources required for green hydrogen production. Moray Council has set an ambitious commitment to become Carbon Neutral by 2030 and take a leading role to assist in the Scottish Government's target of a 75% reduction in regional emissions by 2030 and net zero emissions by 2045.



Hydrogen provides a sustainable alternative to burning fossil fuels and its contribution to helping Scotland reach its net zero targets for industry, transport, power and heat is recognised by the Scottish Government. Hydrogen, produced from renewable energy sources, is a zero carbon, zero emission fuel that can be used for heavy duty vehicles including buses, trucks, agricultural vehicles, marine vessels and trains, and also used to provide heat for industrial uses and for homes. In addition to hydrogen, it is recognised that a significant amount of energy will also be needed from other low carbon sources including electricity.

The Moray Hydrogen Strategy examines the short, medium, and long-term actions required to develop a hydrogen economy for Moray and assesses the significant opportunities to generate local community benefits in relation to social, economic, and environmental wellbeing, supporting Scotland's ambitions on a Just Transition<sup>1</sup>. A key objective for the Council is to retain the benefits of hydrogen energy investment for the people and communities of Moray and help to realise the Council's vision for the region to provide "a life of opportunity for all, where people can thrive in vibrant communities, and where we work together to enrich our future."



A life of opportunity for all, where people can thrive in vibrant communities, and where we work together to enrich our future.



The Scottish Government Hydrogen Policy Statement, published December 2020, sets out Scottish Government support for the strategic growth of a strong hydrogen economy in Scotland. The Minister for Energy, Connectivity, and the Islands provides the following vision in the ministerial forward:



Our vision is for Scotland to become a leading Hydrogen Nation in the production of reliable, competitive, sustainable hydrogen and secure Scotland's future as a centre for international excellence as we establish the innovation skills and supply chain that will underpin our energy transition. Scotland's unique selling points, are its natural resources, infrastructure and skilled energy workforce which enable us to become the producer of lowest cost hydrogen in Europe by 2045.

<sup>1</sup> [Just transition - Climate change - gov.scot \(www.gov.scot\)](https://www.gov.scot/just-transition-climate-change)



The Scottish Government Draft Hydrogen Action Plan, published November 2021, sets out the actions for the next five years to support the development of a hydrogen economy. The Cabinet Secretary for Net Zero, Energy and Transport includes the following statement as part of the ministerial forward:



Hydrogen has a role to play across Scotland in our islands and rural communities, cities and industrial clusters, and strategies for its production and application are expected to vary across these geographic regions. We are committed to realising the benefits of hydrogen to our regions and local communities and so will support regional hubs of hydrogen activity across Scotland, recognising the differing resources, strengths and focuses of each location.

## 2. Stakeholder Engagement

Moray Council has a commitment to become Carbon Neutral by 2030 and will take the leading role to provide the necessary leadership to local business and communities to assist in the Moray wide transition to net zero by 2045.





## 2.1 Introduction and Approach

It is therefore essential that Moray Council can develop an achievable route map to net-zero. Key to delivering this is appropriate levels of engagement with partners and stakeholders to ensure that the strategies taken forward are relevant and tailored to suit Moray and its decarbonisation aims. Critically, it needs to have the buy-in of all partners, stakeholders, local business and the community.

Our approach to building partnership around hydrogen was to hold initial meetings with Moray Council and Highlands and Islands Enterprise (HIE) to identify and map all stakeholders that might have an interest in the development of or the outcome of the strategy.

We then approached each of the identified stakeholders with the aim to obtain the following information that would inform further elements of the strategy:

- Their current energy consumption records (ideally from 2019) and where possible split by source (i.e. gas, electricity etc.) with a monthly breakdown and details on number and size of buildings and/or number of vehicles.
- Their current net-zero plans.
- Their views on hydrogen as potential energy source.

Due to the timescales of the project, we carried out one-to-one sessions for the majority of stakeholders that we could engage with. During the sessions, we sought to discuss and develop the potential direction of the project and how it might be optimised with key stakeholder input.

The engagement with stakeholders generated significant input that informed the Demand Analysis and follow-on sections of this report. The level of positive response indicates a desire from large and small businesses as well as community groups within Moray to support activity that will contribute to achieving the net-zero target. It also highlighted the opportunities to be realised through the development of a hydrogen economy within Moray.

In addition to the one-to-one sessions, we presented to the Moray Climate Assembly (with thanks to tsiMoray for organising). Our presentation provided an overview on Hydrogen as well as a focus on the hydrogen opportunities for Moray.



## 2.2 Stakeholders Engaged

Working with Moray Council and HIE, we identified over 70 stakeholders located within Moray or adjacent to Moray. Figure 2.1 below provides a summary of stakeholders engaged by organisation type.

A copy of the Stakeholder Engagement Tracker is contained in Appendix A. This details each stakeholder that was contacted as part of the engagement process.

Follow-up sessions were also held with several stakeholders to further discuss specific pilot project opportunities as well as to further inform the roadmap to net-zero.

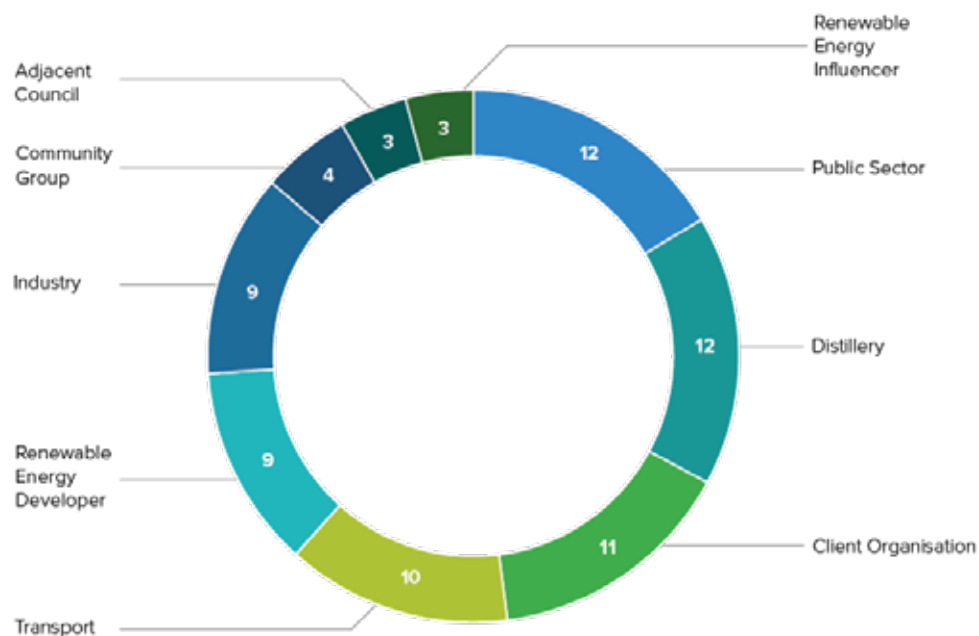

Figure 2.1: Stakeholder Engagement - Summary by Organisation Type  
Source: MM



## 2.3 Key Outcomes from Stakeholder Engagement process

We summarise below the key outcomes of the stakeholder engagement process.

- Most stakeholders engaged were very positive. It was felt that Hydrogen (in particular Green Hydrogen) can form part of the solution to achieve net-zero and the time to act is now.
- There are several supply opportunities available within or very close to Moray. There is a future demand that would be available should a hydrogen supply be available.
- A significant number of stakeholders would like to be involved in the next steps and to assist Moray Council in developing a Hydrogen Economy for the benefit of Moray.
- There will be a number of challenges to take this forward. A collaborative approach is required to take forward and maximise this opportunity for Moray.
- There is a desire within Moray for smaller-scale community-led hydrogen initiatives to be explored in parallel to the large-scale projects.

# 3. Hydrogen Demand

This section of the report details the Hydrogen Demand Study for the Moray Council area which has been conducted with the aim of determining a hydrogen demand forecast to inform the overall Hydrogen Strategy.



Key stakeholders representing business interests in Moray have been consulted to develop an understanding of the market interest and potential take-up rates for hydrogen. Public sector partners including Moray Council, the Highlands and Islands Enterprise, and other bodies such as NHS Scotland and the emergency services have also been engaged to identify opportunities for upgrading transport fleets and heating systems.

For the purpose of the demand study, we have utilised our existing relationships with Scottish Gas and other relevant stakeholders to assess the overall energy demand for the existing gas network with the Moray area. We have also approached the large oil and gas consumers within Moray, including the Distilleries, to obtain detailed consumption data to inform our analysis. To allow a complete picture of energy use in Moray to be built up, we have strived to ensure that this includes all energy users: the industrial and domestic gas users and the off-grid oil and gas users. For each of the industries where actual data has not been readily available, we have aimed to substitute this with assumptions based on our in-house expertise and publicly available data.

Further details on the stakeholders engaged as part of the Hydrogen Strategy are detailed in Section 2 of this report.

Further to this, we have used a desk-based study to assess the wider supply and demand for hydrogen within Moray and the adjacent local authorities, as part of a potential hydrogen corridor through Moray.

Within this section of the strategy report, we will present our hydrogen demand forecast in narrative and tabular form along with maps of the Moray area to illustrate the main locations for hydrogen demand. We will also identify and map short, medium, and long-term hydrogen demand scenarios using a variety of defined, sector dependant, hydrogen uptake scenarios to provide input into the overall hydrogen strategy.

In summary, the largest potential users for hydrogen are the distilleries and domestic properties in the medium to long term, however in the short-term expected demand is from road freight trials including HGVs, buses, refuse vehicles and other council vehicles and grid blending make up the majority of the total projections.



### 3.1 Data

#### 3.1.1 Baseline

This section summarises the sources used in estimating existing demand across various sectors within the Moray Council region.

##### 3.1.1.1 Domestic Demand

###### Domestic (Natural Gas)

Domestic gas use has been based on publicly available Middle Super Output Area (MSOA) gas consumption data for domestic properties published by the Office for National Statistics (ONS). For our analysis we have used data from 2019 and 2020 to estimate current demand.

###### Domestic (Other)

The Scottish House Condition Survey (SHCS), last reported in 2019, states that 27% of dwellings in the Moray Council area are off the natural gas grid. This is relatively high in comparison with the national average of 17% but coincides with the largely rural location of Moray. We have used this figure, alongside the domestic gas data noted above to infer the demand for off-gas grid properties. At this stage there is insufficient data available to estimate the proportion of properties which use oil, LPG, electric heating etc.

##### 3.1.1.2 Non-Domestic Natural Gas

The ONS also publishes MSOA gas consumption data for non-domestic gas consumption, which we have used to establish the existing natural gas demand for the Moray Council area for non-domestic properties. Alongside this, we have obtained actual and estimated consumption for a range of end users, many of whom will be on the gas network.

###### Public Buildings

For public buildings we have obtained gas and oil consumption data for buildings owned and operated by NHS Grampian, Moray Council, Police Scotland and Scottish Fire & Rescue. Combined, these buildings account for approximately 1% of overall total fossil fuel demand in the Moray region.

###### Distilleries

Using a combination of data obtained during stakeholder engagement discussions and energy benchmarks for whisky distilleries to estimate consumption based on production in litres pure alcohol (lpa), we have developed an estimate of the total demand for distilleries in the Moray area. In total there are over 50 distilleries in the Moray Council region, and they account for over 45% of total baseline fossil fuel demand.

Analysis of existing gas infrastructure suggests that approximately 76% of distillery thermal demand is met by natural gas, with the remainder using fuel oil. The below Figure 3.1 shows the distribution of distillery demand across the Moray Council region.

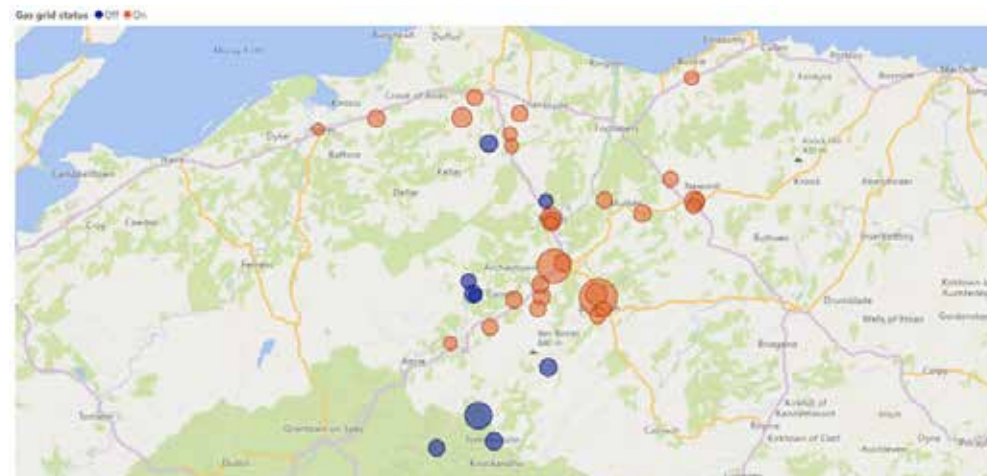

Figure 3.1: Distribution of distillery demand across the Moray Council region

###### Other Manufacturing

We have also obtained consumption data from some other manufacturing sites which are on the natural gas network, including Johnston's of Elgin and Walker's Shortbread sites in Elgin and Aberlour. Together these account for approximately 1% of total current demand.

##### 3.1.1.3 Non-Domestic Off Gas Grid Distilleries

As noted above, using a combination of data obtained during stakeholder engagement discussions and energy benchmarks for whisky distilleries to estimate consumption based on production in litres of pure alcohol (lpa), we have developed an estimate of the total demand for distilleries in the Moray area. In total there are over 50 distilleries in the Moray Council region and they account for over 45% of total baseline fossil fuel demand.

Analysis of existing gas infrastructure suggests that approximately 24% of distillery thermal demand is met by fuel oil.

###### Other off-gas grid Non-Domestic Users

Off gas grid non-domestic users are difficult to estimate without supply information with providers of fuel oil and LPG. As part of this project, it has not been possible to obtain this information, so we have used other data to estimate off gas grid demand. Scottish Government estimate that 5% of non-domestic properties are heated by oil & LPG and so this figure has been used to provide an initial estimate of potential demand.

### 3.1.1.4 Transportation

#### Heavy Goods Vehicles (HGVs)

Transport Scotland data was used to quantify the number of HGVs on the main trunk road, the A96 over the course of a year. This suggests that there are approximately one million HGV journeys along the A96 in Moray each year. This data has been used to estimate the approximate amount of diesel currently consumed by HGVs in the Moray region, and what the equivalent quantity of hydrogen would be.

#### Public Service Vehicles (PSVs)

For PSVs, Transport Scotland data for the number of kilometres travelled was obtained and an appropriate share of this figure was allocated to the Moray Council region based on the number of buses registered there. This figure was used to estimate the quantity of diesel currently consumed by PSVs in the Moray region, and what the equivalent quantity of hydrogen would be.

#### Light Goods Vehicles (LGVs)

The total number of LGVs registered in Moray, combined with the average miles travelled per year for this class of vehicle was used to estimate demand. This figure was used to estimate the quantity of diesel currently consumed by LGVs in the Moray region, and what the equivalent quantity of hydrogen would be.

#### Maritime

Current maritime demand was calculated using an estimated hydrogen demand for each vessel registered at Buckie, to arrive at a theoretical total hydrogen demand.

#### Rail

Rail demand was estimated based on the theoretical transition of all ScotRail services on the Inverness to Aberdeen line being converted to hydrogen.

### 3.1.1.5 Baseline Demand Summary

In developing our baseline estimate, we have attempted to quantify the current total demand for fossil fuels across relevant sectors using available data to establish what the equivalent hydrogen demand would be if all this demand was to switch to hydrogen fuel. This baseline was then used to inform an analysis of the proportion of this demand which could realistically be expected to transition to hydrogen over the short, medium and long term as outlined below.

This approach quantified an annual fossil fuel demand of approximately 2.6 million MWh per year, which would translate to a hydrogen demand of approximately 80,000 tonnes of hydrogen per year. The breakdown of this demand by sector is shown in Figure 3.2 and Figure 3.3 on the right.

As can be seen from the charts, demand is dominated by distilleries (both on and off gas grid), on gas grid domestic and HGVs, together accounting for over 75% of total theoretical demand.

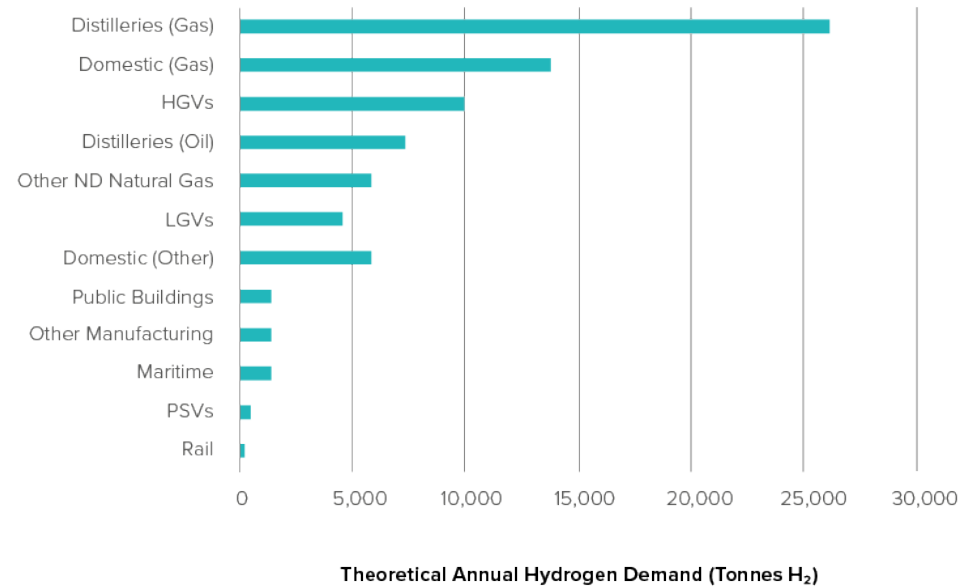

Figure 3.2: Theoretical Tonnes of Hydrogen by Sector

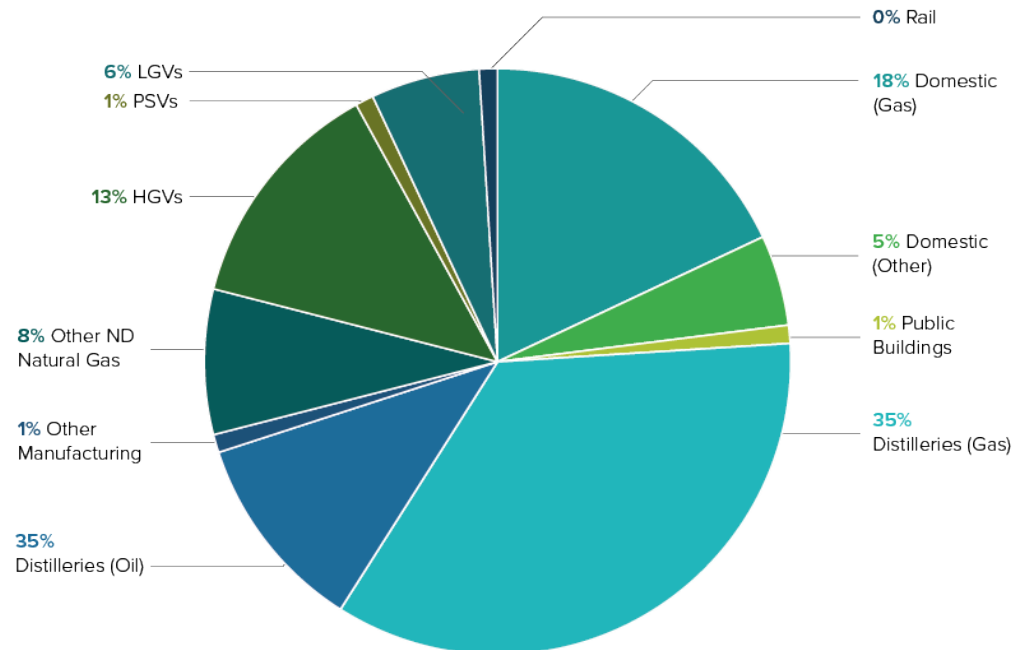

Figure 3.3: Breakdown of Potential Hydrogen Demand by Sector

### 3.1.2 Uptake Scenarios

Having set the theoretical demand across the sectors noted above, we have then made an estimation of the potential uptake over the short medium and long term. We have presented these uptake levels below as percentages of the theoretical maximum. For the purposes of this analysis, we have defined short, medium, and long term as follows:

- Short-term: up to 2030
- Medium-term: 2030 – 2040
- Long-term: 2040 and beyond

The below Table 3.1 sets out our various demand scenarios as percentages of the theoretical total hydrogen demand, and the chart below (Figure 3.4) shows the output of this in terms of total annual demand for hydrogen over the short, medium and long term.

As outlined both in the right figure, medium demand rises from ~11,000 tonnes of hydrogen per annum in the short term, up to ~54,000 tonnes in the longer term, post 2040. A commentary on the basis of the assumptions which make up the above estimates is stated below.

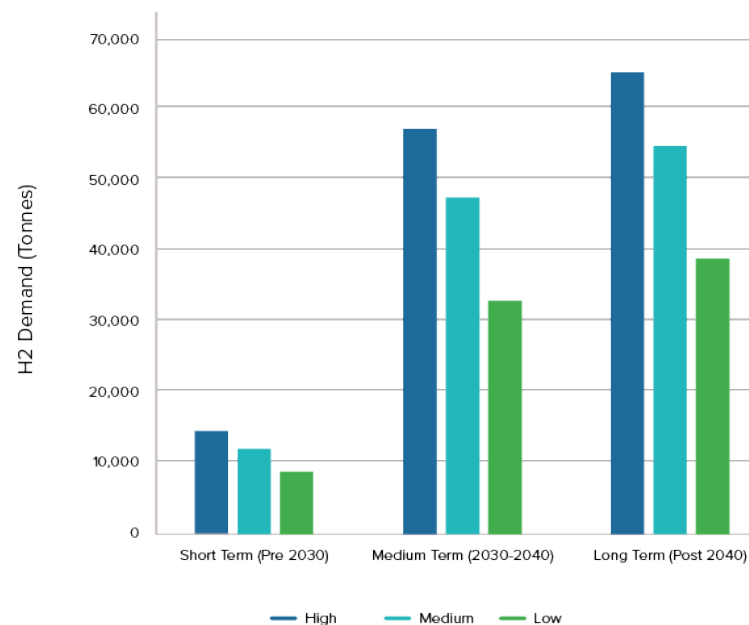

Figure 3.4: Annual Hydrogen Demand Projections

Sector	Short Term, High Demand	Short Term, Medium Demand	Short Term, Low Demand
Domestic (gas)	0%	0%	0%
Domestic (other)	0%	0%	0%
Public Buildings	0%	0%	0%
Distilleries (Gas)	10%	5%	0%
Distilleries (Oil)	20%	10%	0%
Other Manufacturing	0%	0%	0%
Other ND Natural Gas	0%	0%	0%
Other ND Off Gas Grid	20%	10%	0%
HGVs	30%	20%	10%
PSVs	15%	10%	5%
LGVs	10%	5%	0%
Maritime	10%	5%	0%
Rail	0%	0%	0%
Blend	100%	50%	0%
<b>TOTAL</b>	<b>23%</b>	<b>12%</b>	<b>1%</b>

Medium Term, high Demand	Medium Term, Medium Demand	Medium Term, Low Demand
90%	80%	50%
5%	3%	0%
70%	60%	50%
80%	70%	60%
40%	30%	20%
100%	80%	60%
70%	60%	50%
30%	15%	0%
50%	40%	30%
25%	20%	15%
10%	5%	0%
0%	0%	0%
0%	0%	0%
0%	0%	0%
63%	54%	41%

Long Term, High Demand	Long Term, Medium Demand	Long Term, Low Demand
90%	80%	50%
10%	5%	0%
70%	60%	50%
80%	70%	60%
80%	60%	40%
100%	80%	60%
70%	60%	50%
40%	20%	0%
100%	80%	60%
50%	40%	30%
20%	10%	0%
0%	0%	0%
0%	0%	0%
0%	0%	0%
75%	63%	47%

Table 3.1: Various Demand Scenarios

### 3.1.3 Future Demand Assumptions

This section explains the future demand assumptions and the basis on which they are calculated.

#### 3.1.3.1 Domestic Demand

##### Short Term

In the short term, pre- 2030, it is assumed that there will be no domestic hydrogen demand. This is for two reasons. The UK Government's plan for hydrogen involves the delivery of a village trial by the mid-2020s to inform the policy decision on the grid conversion to hydrogen. If the decision to switch to hydrogen is taken, then conversion of the grid network is unlikely to commence before 2030 and therefore we have assumed there will be no domestic demand from those premises on the gas network in the short term.

With regards to off-gas grid properties, it is in theory possible that there could be some domestic demand for road supply before 2030, however this is thought to be unlikely in these timescales, and if there were to be any users before 2030 it is likely that they would only be a small quantity.

# 80%

of distilleries may take advantage of hydrogen supply

##### Medium to Long Term

In the medium to long term, on gas grid domestic demand could increase significantly if there was to be conversion of the gas grid to hydrogen. In the event that this were to happen then hydrogen could be made available to all homes on the gas grid in a relatively short period of time. It is difficult at this stage to gauge what level of uptake there may be from domestic consumers as the situation is relatively unprecedented (retaining the status quo would not be an option). However, we have presented three plausible scenarios of 50%, 80% and 90% uptake by domestic consumers for both the medium and long term. The reason for projecting the same estimate for both is that conversion, were it to happen, may well do so in the medium term and it appears unlikely that there would be significant additional uptake following conversion (unless the gas network was to be expanded). For off gas grid properties, any uptake would depend on the development of a bulk hydrogen supply chain. At present, nationally, it is estimated that approximately 10% of homes are heated by oil & LPG so it seems reasonable that this would be the maximum that could in theory convert to hydrogen. In light of this, we have modelled the below scenarios:

- Medium Term: 0%, 3% and 5%
- Long Term: 0%, 5% and 10%

This is based on the hypothesis that off gas grid demand may develop more gradually than on gas grid over time.

#### 3.1.3.2 Non-Domestic Natural Gas Public Buildings

Similar to the situation with domestic properties, we do not expect there to be any hydrogen demand specifically for this area in the short term, for the reasons set out above. However, in the medium to long term we anticipate demand could be in the range of 50% - 70% of the theoretical maximum. The upper estimate is slightly lower than for domestic properties as it may be that organisational targets in the public sector may drive some operators to switch to low carbon heat solutions such as heat pumps before hydrogen becomes available.



##### Distilleries

Distilleries use large quantities of fossil fuels for the production of steam, which is required for their production process. The majority of distilleries in the Moray region have mains natural gas supplies. Distilleries are well engaged in the journey to net zero. In the medium to long term when hydrogen may be available via the existing gas network demand could be high, due to the challenging nature of steam production by other means. This is reflected in the estimates set out below:

- Short Term: 0%, 10% and 20%
- Medium Term: 60%, 70% and 80%
- Long Term: 60%, 70% and 80%

If the gas network were to be converted then it is possible that up to 80% of distilleries may take advantage of hydrogen supply, as it may well represent the most viable option for them to achieve net zero. This is reflected in our upper estimates in the medium to long term.

The biggest barrier to deployment of hydrogen in on gas grid distilleries is likely to be the timescales for the development of a hydrogen supply chain. Some distillers, such as Diageo (which accounts for ~20% of total demand in Moray), have 2030 Net Zero targets and have already developed route-maps for their distilleries which assume hydrogen will not be available. Whilst they would be interested if hydrogen supply were to become available, they are not considering switching any distilleries to 100% hydrogen fuel.





### 3.1.3.3 Non-Domestic Off Gas Grid Distilleries

As noted above, the production of steam is essential for distilleries and those that are not connected to the natural gas grid typically use fuel oils, though some do use biomass and biogas to meet a proportion of steam demand. Given the requirement for high temperatures in the distilling process, hydrogen could be an attractive option even for off-gas grid facilities as it may allow the boiler to be converted to hydrogen with no other changes required to the process.

- Short Term: 0%, 10% and 20%
- Medium Term: 20%, 30% and 40%
- Long Term: 40%, 60% and 80%

If bulk hydrogen supplies were to become available then supply to distilleries could grow from low levels in the short term to a high proportion of distilleries in the medium to long term, if hydrogen offers the best route to decarbonisation.

### Other off-gas grid Non-Domestic Users

For other off-gas grid non-domestic consumers, it is likely that uptake will be relatively low, as summarised in the figures below. For lower temperature uses such as space heating or low temperature process requirements, heat pumps are likely to be the preferred option for many consumers.

- Short Term: 0%, 10% and 20%
- Medium Term: 0%, 15% and 30%
- Long Term: 0%, 20% and 40%

The above figures present plausible scenarios for the use of hydrogen on off-gas grid facilities from zero up to potentially 40% of the theoretical maximum in the long term.



# 2040

the government are committed to phasing out diesel HGVs

### 3.1.3.4 Transportation Heavy Goods Vehicles (HGVs)

For HGVs, it is likely that hydrogen, rather than electrification will be the preferred option for decarbonisation in the future, and the question is to what extent this will be the case and how quickly the transition will happen. The UK government have recently committed to phasing out diesel HGVs by 2040 and so the trajectory towards this should become clear in the coming years.

- Short Term: 10%, 20% and 30%
- Medium Term: 30%, 40% and 50%
- Long Term: 60%, 80% and 100%

The above scenarios are plausible projections of what proportion of total HGV demand could be met by hydrogen in the short, medium and long term.

### Public Service Vehicles (PSVs)

For PSVs, the picture is similar. It is likely that hydrogen, rather than electrification will be the preferred option for decarbonisation for larger buses, and the question is to what extent this will be the case and how quickly the transition will happen. We have estimated the following.

- Short Term: 5%, 10% and 15%
- Medium Term: 15%, 20% and 25%
- Long Term: 30%, 40% and 50%

The above scenarios are plausible projections of what proportion of total PSVs demand could be met by hydrogen in the short, medium and long term. This is lower than for HGVs as there is a higher likelihood of electrification playing a larger role in this sector.



### 3.1.3.5 Summary

In summary, there are a range of potential outcomes with regards to hydrogen demand in the future. Of the total theoretical hydrogen demand of just under 80,000 tonnes per year we project the following scenarios:

- Short Term: 1%, 12% and 23%
- Medium Term: 41%, 54% and 63%
- Long Term: 47%, 63% and 75%

Figure 3.5 below shows the breakdown of these scenarios by sector.

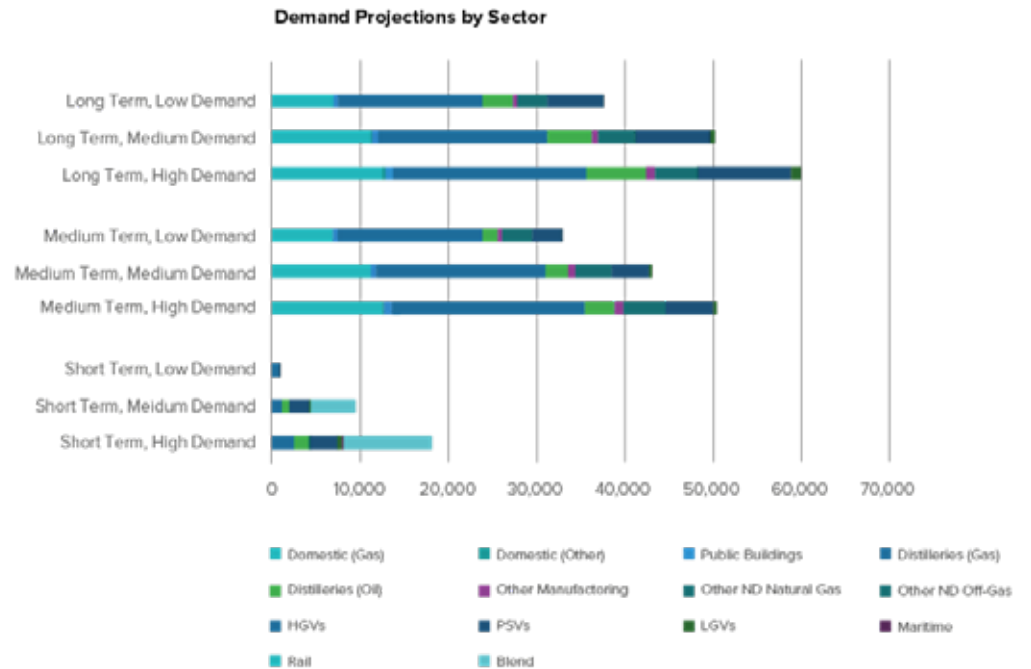

Figure 3.5: Breakdown of Scenarios by Sector

### Light Goods Vehicles (LGVs)

For LGVs, it is likely that electrification will dominate the drive towards decarbonisation. However, it may be that there will be some demand for hydrogen from larger vehicles. The following high-level estimates were made for this sector.

- Short Term: 0%, 5% and 10%
- Medium Term: 0%, 5% and 10%
- Long Term: 0%, 10% and 20%



As can be seen in Figure 3.5 above the largest potential contributors are distilleries and domestic properties in the medium to long term, however in the short-term demand from HGVs and grid blending make up the majority of the total projections.

## 4. Renewable Energy

The current and planned renewable energy sources within Moray could be used to provide green power to potential hydrogen generation facilities and support the development of a hydrogen economy. The renewable energy in Moray is generated by onshore and offshore wind farms and land based solar farms. The grid electrical power can also be used to provide power to hydrogen generation facilities utilising electricity from green sources and higher carbon sources.





## 4.2 Offshore wind

Four offshore windfarms have been identified, as detailed in Table 4.2. Of these, two of the corresponding onshore substations are being built within Moray's geographical boundaries: Moray East and Moray West. These onshore substations are identifiable in dark blue within Figure 4.1. Operations commenced in 2021 at Moray East windfarm and commencement of operations for Moray West windfarm is expected in 2024.

Name	Developer	MW	Future MW	Future MW Year	Latitude	Longitude
Moray East	Ocean Winds	-	950	2022	57.4917866	-2.2839007
Moray West	EDP renewables and ENGIE	-	850	2024	57.5055678	-2.9253252
Beatrice	SSE Renewables	588	-	-	57.5225943	-2.9477369
Caledonia	Ocean Wind	-	1000	2028	-	-

Table 4.2: Offshore wind farms in the Moray Firth

In addition, the Crown Estate have issued option agreements through ScotWind Leasing which will lead to the development of 17 offshore wind projects, further enhancing the opportunities for utilising green electricity within Moray and Scotland.

Beatrice offshore windfarm is already operational, with power supplied to the grid at its onshore substation, New Deer, located 20 km into Aberdeenshire.

## 4.3 Solar

Three solar PV systems have been identified in Moray with over 5 MW of installed capacity, as detailed in Table 4.3. Elgin Energy has secured planning to proceed with the 20 MW and 50 MW projects near Urquhart and the Milltown Airfield respectively. All three solar plants are visible in Figure 4.1. in yellow.

Name	Developer	MW	Future MW	Future MW Year	Latitude	Longitude
Urquhart Solar Power Project	Elgin Energy	-	20	2025	57.648285	-3.1984769
Solar PV Milltown Airfield	Elgin Energy	-	50	2025	57.675252	-3.2324848
RAF Lossiemouth	MoD	-	tbc	2024	57.710353	-3.3079101

Table 4.3: Solar PV systems in Moray greater than 5 MW in capacity

## 4.4 National Grid Supply

Demand headroom is a measure of spare capacity at the substation and is calculated by subtracting the maximum load recorded in the previous year from the substation's installed capacity. The greater the demand headroom, the greater the amount of power that can be drawn from the network. Substations in Moray with over 8 MW demand headroom are visible in green in Figure 4.1 (above) and detailed in Table 4.4 below. Note that the Nairn GSP is not actually located within Moray.

Name	Developer	Headroom (MW)	Voltage (kV)
Lossiemouth	SSEN	8	33 / 11
Ballindalloch	SSEN	12	33 / 11
Kinloss	SSEN	12	33 / 11
Buckie	SSEN	13	33 / 11
Bilbohall	SSEN	19	33 / 11
Nairn GSP	SSEN	29	132 / 33
Keith GSP	SSEN	40	132 / 33
Elgin GSP	SSEN	42	132 / 33

Table 4.4: 33/11 kV substations in Moray at least 8 MW headroom



#### 4.5 Energy Supply for Hydrogen

The actual capacity of the electricity generator to produce electricity depends on the number of hours the generator is in operation. The capacity factor of the generator is a measure of the total electricity generated compared with the number of hours. For renewable energy sources, the capacity depends on the availability of wind and the amount of sun. The grid supply in contrast is almost continuous.

For Moray the assumed capacity factors are as follow:

- Offshore Wind: 50%
- Onshore Wind: 30%
- Solar: 25%
- Grid Electricity: 100%

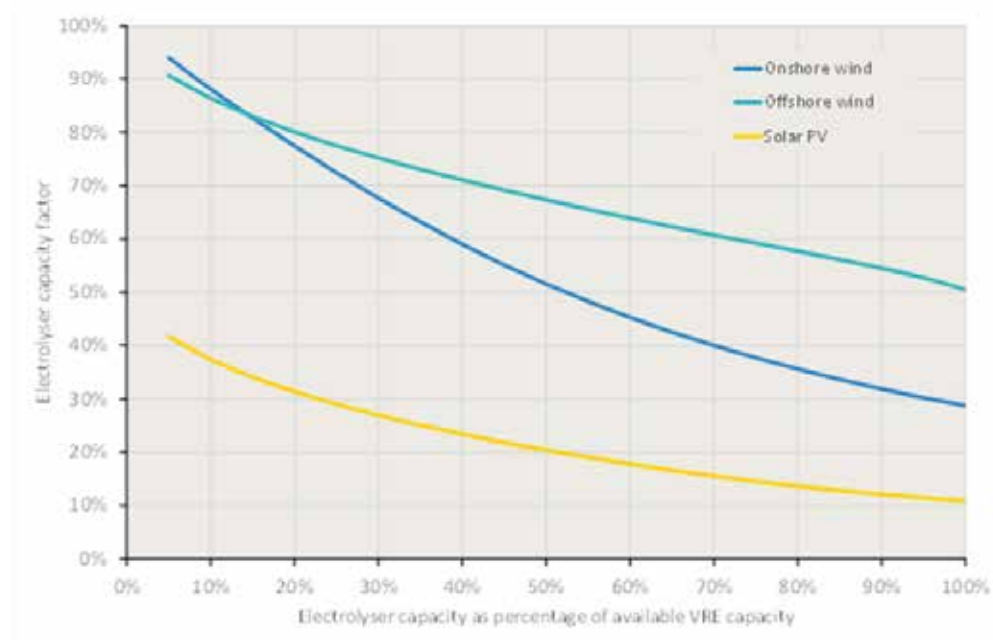

Figure 4.2: Electrolyser capacity factor given VRE supply

Source: Mott MacDonald



# 5. Hydrogen Production

Hydrogen can be produced in Moray from the electrolysis of water, utilising green electricity or grid electricity. Green electricity is provided from wind and solar sources within Moray or offshore within the Moray Firth.



## 5.1 Introduction

For the Moray Hydrogen Strategy, the following factors have been considered for hydrogen production:

- Electrolyser technology selection
  - Utilities (water supply, power supply)
  - Hydrogen storage requirements (bulk vs local)
  - Hydrogen distribution method (via tube trailer and/or pipeline)
  - Hydrogen re-fuelling stations
  - Hydrogen storage requirements (bulk vs local).
- Offshore, adjacent to the wind turbines
  - Onshore, adjacent to renewable energy sources
  - At a central location close to the potential main users of hydrogen in Moray
  - At a central location aligned with the existing electrical distribution network (such as Blackhillock substation)
  - At distributed locations on a small scale located adjacent to key users of hydrogen at point of use (such as close to a Distillery)
  - At a location outside Moray.

These factors influence the potential locations for hydrogen generation within Moray. The following locations have been considered:



## 5.2 Electrolyser Technology

Hydrogen is produced via electrolysis by passing electricity through two electrodes in water. The water molecule is split and produces oxygen at the anode and hydrogen at the cathode. Regardless of the technology, the overall electrolysis reaction is the same:

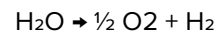

Electrolysis is a well-established green technology for hydrogen generation; thus, it has been selected as the hydrogen production technology for the potential generation of hydrogen within Moray. A general flow diagram showing major equipment items to produce hydrogen via electrolysis is shown below.

Variations in this process exist for the different types of electrolyser technologies.

Electrolysers are differentiated by the electrolyte materials used and the temperature at which they are operated. There are several electrolyser technologies, these are:

- Alkaline (ALK)
- Proton Exchange Membrane (PEM)
- Solid Oxide (SO)
- Anion Exchange Membrane (AEM).

Anion Exchange Membrane (AEM) electrolysis and Solid Oxide Electrolysis (SOE) are still in the demonstration phase; hence they are currently not considered to be a viable option for this project.

The two commercially available electrolysis technologies available in the marketplace today are Alkaline Electrolysis (ALK), and Proton Exchange Membrane (PEM) electrolysis. Historically, alkaline electrolysis has dominated the market and accounted for a large proportion of the installed electrolysis capacity worldwide. More recently there have been a growing number of projects based around PEM electrolysers.



### 5.2.1 Alkaline Electrolysis (ALK)

Alkaline Electrolysers employ an aqueous solution of potassium hydroxide (KOH), typically 30t% KOH because of its high conductivity. Alkaline Electrolysers have a simple stack and system design and are relatively easy to manufacture. These units can be either unipolar or bipolar. The unipolar electrolyser resembles a tank and has electrodes connected in parallel. A membrane is placed between the cathode and

anode, which separate the hydrogen and oxygen as the gasses are produced but allows the transfer of ions. The bipolar design resembles a filter press. Electrolysis cells are connected in series, and hydrogen is produced on one side of the cell, oxygen on the other. Again, a membrane separates the electrodes. The main reason for the bipolar arrangement is the savings in space. The main reason for the bipolar arrangement is the savings in space.

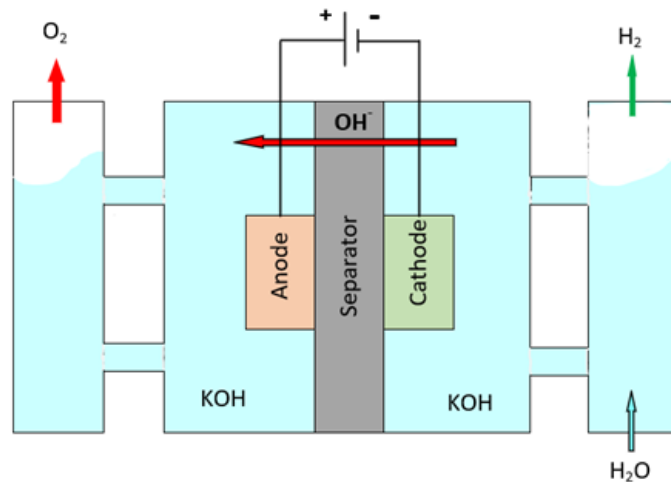
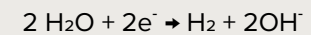

Figure 5.1: Alkaline Electrolysers Cell.  
Source: Mott MacDonald

In an alkaline system the reaction at each electrode is:

#### Alkaline Hydrogen Production at the Cathode



#### Alkaline Oxygen Production at the Anode

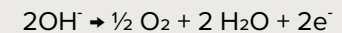

Since liquid alkaline electrolytes are less corrosive, the electrodes can be made relatively cheap metals such as Ni, Fe and Co.



### 5.2.2 Proton Exchange Membrane Electrolysis (PEM)

In Proton Exchange Membrane (PEM) Electrolysers, the electrolyte is a solid ion conducting membrane as opposed to the aqueous solution in the alkaline electrolysers. The membrane allows the H<sup>+</sup> ion to transfer from the anode side of the membrane to the cathode side, where it forms hydrogen. The membrane also serves to separate the hydrogen and oxygen gasses, as oxygen is produced at the anode on one side of the membrane and hydrogen is produced on the opposite side of the membrane. A commonly used PEM material is Nafion. Developed in the 1970s by Dupont, Nafion consists of polytetrafluoroethylene (PTFE) chains, commonly known as Teflon forming the backbone of the membrane. Attached to the Teflon chains, are side chains ending with sulphonic acid (HSO<sub>3</sub>) groups.

The PEM system reactions at the electrodes are:

#### PEM Hydrogen Production at the Cathode

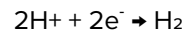

#### PEM Oxygen Production at the Anode

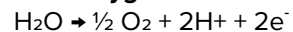

Since this design employs an acid environment, the electrodes are typically made from metal such as Pt, Ir and Ru. These electrodes provide high performance and reliability, but they are expensive, and subject to price volatility, for example the high cost of platinum.

PEM systems can be designed to operate in a number of modes: atmospheric, differential, and balanced pressure (however the design must be fixed to a single mode).



Under a balanced pressure operation, the anode and cathode are designed to run at the same pressure level of up to 30 bar. With atmospheric pressure operation the electrolyser operates near atmospheric pressure. In the differential mode, a differential pressure of up to 30 bar operates across the stack. This, however, requires a thicker membrane to improve the mechanical stability and decreases gas permeation, which reduces efficiency.

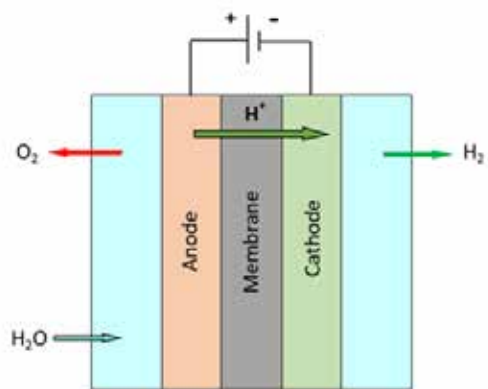

Figure 5.2: PEM Electrolysers Cell. Source: Mott MacDonald

Alkaline Water Electrolysis	PEM Water Electrolysis
<b>Advantages</b>	
Well-established technology	Smaller stack size
Large stacks available	Fast dynamic response
Lower investment costs	Good partial load tolerance
Slightly higher efficiency	High pressure operation without compression
	Slightly higher hydrogen purity
<b>Disadvantages</b>	
Slightly lower hydrogen purity	Higher investment cost
Lower partial load tolerance	Acidic corrosive environment
Slower dynamic response	Shorter stack life
Low operational pressures	Smaller stacks
Corrosive liquid electrolyte	

Table 5.1: Summary of the Advantages and Challenges of the Technologies

### 5.3 Electrolyser Technology Evaluation

Due to their different designs Alkaline and PEM electrolysers have advantages and disadvantages, which have been briefly outlined below. Although both technologies can be applied to applications in Moray, it is considered that Alkaline electrolyser systems are cheaper and more proven, so should be the primary choice.

## 5.4 The Hydrogen Production Facility

The proposed hydrogen generation facilities selected for Moray include the electrolyser, gas purification (oxygen and water removal), storage and compression. A general flow diagram showing major equipment items to produce hydrogen via electrolysis is shown in Figure 5.3. Variations in this process exist for the different types of electrolyser technologies.

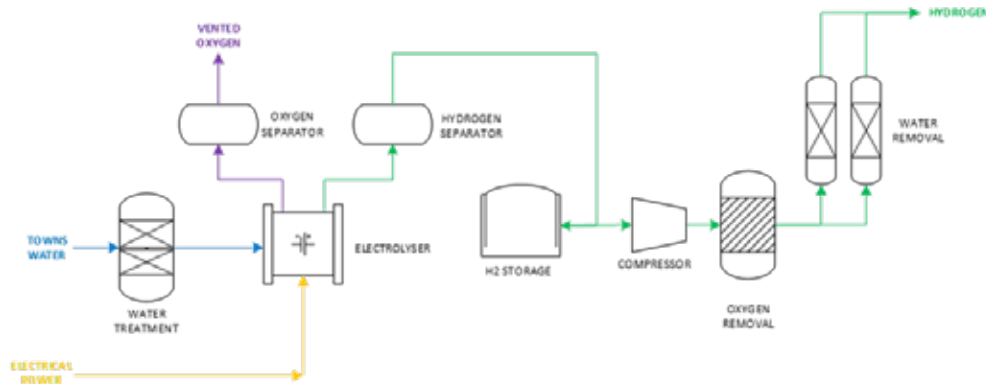

Figure 5.3: Hydrogen Production Facility  
Source: Mott MacDonald



### 5.4.1 Electrolyser System

The transformer and rectifier are required to convert the AC high voltage supply into the DC current required by the electrolyser. Multiple electrolyser stacks will be provided to supply the required hydrogen production, operational flexibility, and system maintainability. The hydrogen gas is generated at the cathode and the oxygen gas at the anode.

The Alkaline electrolyser system includes electrolyte management as well as pressure management systems for keeping the oxygen and hydrogen sides equalized. The pressures on the anode and cathode sides of the cell must always be equalized to prevent gas crossover

through the porous cell separator. The Alkaline electrolyser uses a 30% KOH solution as the electrolyte, the electrolyte system includes the piping and pumps to circulate the electrolyte and an electrolyte storage tank.

Hydrogen and oxygen leaving the electrolyzers must be separated from the electrolyte. This is done in gas-electrolyte separators that are placed above the stack. The gas leaves from the top of the separator and electrolyte from the bottom. A scrubber is also provided after the hydrogen separator to remove residual traces of electrolyte from the hydrogen gas stream.

Heat is generated in the electrolyser stacks, so the electrolyte is cooled before it is returned to the electrolyser.



A suction drum is provided between the scrubber and the compressor. The compressor compresses the near atmospheric pressure gas to the 500-bar buffer storage pressure. After leaving the compressor any trace amounts of oxygen can be removed by catalytic reaction in a deoxidiser. A dryer package which typically consists of twin towers filled with a desiccant will also be provided to absorb the remaining water to achieve the desired dew point.

The system will comply with ISO 14687 and SAE Y2719, the standards for hydrogen road vehicles. Both of these require <5 ppm (by volume) of oxygen and water.

### 5.4.2 Water Supply

The production and availability of high-quality water for the electrolyser is a critical step in the hydrogen production process. Both Alkaline and PEM electrolyser systems require deionised water. Various water sources can be used for example towns water, seawater, river water, and brackish groundwater. The design and cost of the water treatment facility will depend on the water source and water quality required by the type of electrolyser.

Water for the potential hydrogen production facilities for Moray will be provided from the towns water mains supply. It is assumed that there is sufficient capacity of towns water to supply to each of the locations selected. River water from the River Lossie or River Spey could provide an alternative source of water although additional feed water treatment may be required. The water volume required for electrolysis is small compared to other industrial users such as the distilleries. However, it is recognised that water levels in the springs and rivers within Moray and the Scottish Highlands can fall to low levels during summer periods of high temperatures with little rainfall. Further analysis and engagement with Scottish Water and the Scottish Environment Protection Agency (SEPA) will be required to confirm the water sources, availability, and quality.

### 5.4.3 Power Supply

Electrical power for electrolysis will be provided through cabling from either renewable energy sources or directly from the grid. The distance from the power source to the electrolyser will influence cabling costs and can impact on the overall viability of a scheme.

The capacity factor of a power source is the ratio of average power output that can be delivered. The electrical power available from renewable energy sources is variable which is reflected in a lower capacity factor. To compensate for lower capacity factors from renewable powers sources, electrolysers can be oversized to produce more hydrogen when power is available alongside increased storage capacity.



The amount of potential grid power available at a site is determined by measuring the spare capacity at the nearest substation, known as the headroom. The greater the headroom the greater the amount power that can be drawn from the network. This is considered when selecting potential electrolyser sites with Moray. Alternative sources of grid power could be made available which will require significant new infrastructure and investment.

### 5.4.4 Hydrogen Transport and Distribution

Hydrogen for pilot projects, transport trials and small-scale industrial applications is typically produced by electrolysis at a facility that includes hydrogen storage and refuelling systems. An example is the hydrogen refuelling system provided for the Aberdeen hydrogen bus fleet. As the demand and supply for hydrogen increases, siting a higher capacity electrolyser at a central location or hub with distribution of hydrogen to multiple hydrogen refuelling stations or industrial users is a potential solution that could offer cost benefits. This approach could be applied within Moray in the medium and long term.

Hydrogen can be transported using the following methods:

- **Pipelines:** For the delivery of large amounts of hydrogen
- **By road as cryogenic liquid:** Intermediate amounts of hydrogen can be transported as a cryogenic liquid in super-insulated tank trucks.
- **By road as compressed gas:** Smaller amounts of hydrogen gas can be compressed and transported over the road in high pressure tube trailers.

Tube trailers are competitive at short delivery distances with small volumes. The principal advantage of gaseous tube trailer delivery is that it avoids the high liquefaction energy cost or pipeline investment costs and installation times. Over long distances tube trailer delivery costs become high. As well as high operating costs, depending on the volume of hydrogen transported, investment costs may also be high due to the number of tube trailers required.

In the long term, hydrogen may be distributed through a local or national pipeline network from centralised industrial scale hydrogen production sites. The network could be a new pipeline system, or it could be developed by repurposing the existing gas distribution network (as natural gas is withdrawn as an energy source).

### 5.5 Hydrogen Storage

The hydrogen storage capacity and locations will need to be considered as part of the overall hydrogen strategy for Moray.

Bulk hydrogen storage is required at the electrolyser and normally provides between 1- and 5-days production to allow for swings in demand and production, and to allow for planned or unplanned maintenance.

In addition, storage is required at the hydrogen user's site if there is no connected pipeline. It is possible to leave a tube trailer at the user's site and replace when empty. Alternatively, the user can provide their own permanent storage facilities. It is assumed that local bulk hydrogen storage within Moray will be as pressurised gas (separate liquid hydrogen storage may be required depending on identified liquid hydrogen consumers). Further analysis is required to optimise the medium- and long-term storage solutions for Moray.



# 1000kg

of hydrogen produced a day at a refuelling station

A HRS typically consists of the following main components:

- MP hydrogen storage tank:
- Hydrogen HP gas compressors,
- High pressure hydrogen storage tanks, and
- Hydrogen dispenser.

Hydrogen refuelling station equipment is now widely available from many suppliers within the UK and Europe for hydrogen cars, busses, and HGVs.

Hydrogen refuelling stations can store and dispense hydrogen in the form of either liquid or gas. Refer Figure 5.4 for an example of main equipment and process for a typical gas HRS. While liquid hydrogen can reduce storage footprint requirements, it requires an intensive cooling system which can be more energy intensive compared to hydrogen gas. For Moray, hydrogen gas is proposed.

A hydrogen refuelling station that can produce 1000 to 1125 Kg of hydrogen a day is suitable for operating approximately 30 HGVs per day.

### 5.6 Hydrogen Refuelling Stations (HRS)

Hydrogen refuelling stations are provided to dispense hydrogen for transport use. The hydrogen supply pressure for large vehicles such as refuse trucks, buses, and HGV's is typically 350 bar, since larger vehicles such as buses and trains tend to have more available storage space, while cars and smaller commercial vehicles have adopted the 700-bar standard.

Basic concept: Ionic Compressor System

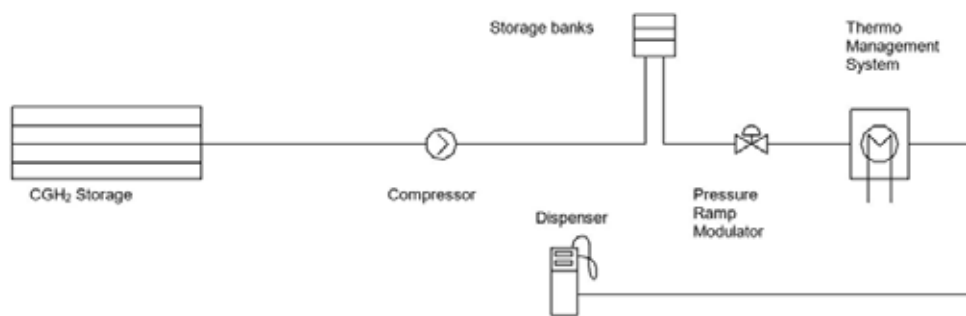

Figure 5.4: Hydrogen Refuelling Station  
Source: Mott MacDonald

## 5.7 Electrolyser Sizes

To start an immediate road freight trial in Moray to stimulate the hydrogen economy by creating a demand for “back to base” vehicles in the 20 to 25 tonne range, such as bus or refuse truck fleets, an electrolyser producing 1,000 kg a day of hydrogen is recommended. This is in-line with the market capability for small scale electrolysers and the market availability for hydrogen buses and the medium sized goods vehicles.

As the demand grows towards 2030, a hydrogen requirement of approximately 27,000 kg a day is predicted. Based on the annual short term hydrogen demand of 10,000 tonnes/yr. for Moray and assuming an offshore wind power supply with a capacity factor of 50%, a 130 MWe electrolyser system (which includes losses) will be required. If the electrolyser is connected directly to the grid, a 100% capacity factor can be used, reducing the electrolyser size to 65 MWe.



A primary large-volume, centrally placed hydrogen production facility will typically require for 1 to 5 days of hydrogen storage to accommodate wind profiles, demand fluctuations and short-term outages

For Moray, the storage requirement is assumed to be equivalent to one day's production which is 1,000 to 27,000 kg. This will make this facility a lower tier COMAH site (greater than 5 tonnes of hydrogen) and the appropriate approval will be required as part of the site permitting process.

# 27,000

kilograms of hydrogen  
approximately to be required a day  
as demand grows to wards 2030

Hydrogen Demand Kg/Day	Hydrogen Demand Tonnes/Year	Capacity Factor	Electrolyser Size MWe	Approx. Footprint m2
1000	365	100%	2.3	663
27,000	10,000	50%	130	25,000
27,000	10,000	100%	65	12,000
126,000	46,000	100%	300	50,000

Table 5.2: Electrolyser Sizes



## 6. Moray Hydrogen Production

Potential locations for the production of hydrogen within Moray were evaluated to take into account the views of the stakeholders, the predicted demand for hydrogen in the short, medium and long term, and the availability of electrical power. Also considered were the existing initiatives for economic development and reducing poverty within Moray.



## 6.1 Introduction

Six potential locations have been identified to produce hydrogen within Moray during the short, medium and long term.

## 6.2 Short Term Production Locations (to 2030)

Introducing hydrogen production in Moray in the short term by delivering a pilot sized project to encourage demand, stimulate the economy, test the infrastructure and provide opportunities for learning for further growth. There are four potential pilot project locations that can be considered for immediate implementation. These are outlined below. It should be noted that for all potential pilot projects, further work is required to identify supporting partners, to determine initial levels of demand to inform the size of the pilot project as well as suitable and available locations.

### 6.2.1 Lossiemouth

This opportunity was identified during the stakeholder engagement phase with RAF Lossiemouth. The RAF are intending to install a Solar PV Array on Ministry of Defence (MoD) land just outside the RAF Lossiemouth Station boundary. There is an opportunity for Moray Council to partner with RAF Lossiemouth to develop a pilot project to produce hydrogen in Lossiemouth.



A combined electrolyser and hydrogen refuelling station would be located approximately six miles from Elgin and could offer a hydrogen re-fuelling station for Council HGVs. The RAF are investigating the potential of powering their larger vehicles with hydrogen and so there is further opportunity for cost-sharing of the hydrogen infrastructure and for this to be further developed beyond the pilot stage.

Further work is required to be carried out with the RAF to determine the spare capacity, options for expanding the Solar PV Array and the land that would be required for the hydrogen infrastructure including a fuelling area. It is likely that to make a viable hydrogen hub, the available solar energy will need to be added to with a grid connection.

### 6.2.2 Aberlour

Aberlour was identified as a pilot project for hydrogen generation due to the concentration of whisky distilleries and major transport logistics companies based in or close to Aberlour. Due to the demand in this area and the desire of industry within the area to be part of the hydrogen economy, a hub within Aberlour has a high chance of success. The transport logistics companies within Aberlour are currently investing in hydrogen vehicles and hydrogen technology. They are interested in working with Moray Council to develop a hydrogen solution for the whisky transport industry.

A hub in Aberlour would provide a “southern” Moray hub and link on A95 between Keith and Grantown on Spey / Aviemore (and onward to Perth and the Central-Belt). Consideration should also be given to expansion of pilot project to meet forecast medium and long-term demand in this area.





### 6.2.3 Buckie Harbour

Buckie Harbour was identified as a potential pilot project location during the stakeholder engagement phase with Moray Council and local industry. The maintenance base for the Moray East and Caledonia offshore wind farms (Ocean Winds) will be Buckie Harbour. Ocean Winds intend to operate their Crew Transfer Vessels (CTVs) using Hydrogen (potentially from 2025). There is also potential demand for hydrogen from the fishing industry in Buckie Harbour as well as HGVs from the Maltings and other heavy industry in and around Buckie.

There is significant potential demand at this location. This would also act as a development agent within Buckie and support the Council's Harbour masterplan ambitions.

### 6.2.4 Elgin

Elgin was identified as a potential location for hydrogen production and a pilot project due its central location within Moray and the significant amount of potential "early" hydrogen users such as Moray Council's large-vehicle fleet.

Elgin is the base for the majority of the Council's large-vehicle fleet and also has a large bus depot. It is the main centre for emergency services vehicles within Moray as well as many other potential hydrogen vehicles users from industry and therefore maximise the chances of success for a pilot project. These "back to base" transport users such as the bus fleets or refuse vehicles are ideal first applications for hydrogen.

The A96 runs through Elgin and significant volumes of HGVs go through Elgin on a daily basis. A location close to or on the A96 would be attractive to potential users and provide a connection on the A96 for Hydrogen users between Aberdeen and Inverness. For example, re-configuring part of the Lossie Green Car Park that currently has HGV parking or a new HGV parking facility with a hydrogen fuelling station would be attractive to transport companies.

It should be noted that a similar pilot project hub could be placed in Forres or similar sized town if it was felt that in the short-term this offered more benefit and there was desire from industry in Forres to support.



### 6.3 Medium Term Production Locations (2030-2040)

As the hydrogen demand expands within Moray and the hydrogen economy develops, any installed electrolyzers could be expanded. By this time, hydrogen could also be purchased and delivered from suppliers based outside the Moray area as more hydrogen generation facilities become operational in Scotland. Transitioning the hydrogen production from small to medium and large-scale would be relatively straight forward. Firstly, due to the modular nature of electrolyzers, the stacks can be easily combined in groups to give various plant/block sizes as show in Figure 6.1. Secondly, as part of the project development plan, new blocks can be added over time. The use of this type of repeat engineering would reduce overall engineering costs and simplify procurement. The additional blocks could also be added early or delayed depending on actual demand growth. A degree of forward planning would be required, for example allowing additional plot space for the future blocks, and the provision of tie-in points at existing blocks and infrastructure to simplify connection of the new systems.

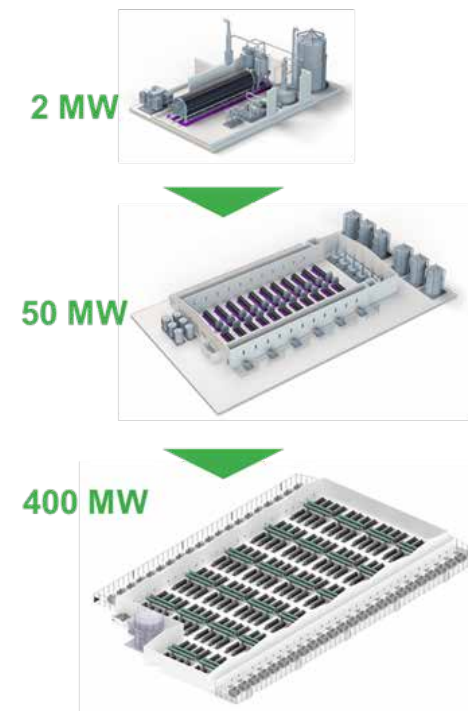

Figure 6.1: Modular Nature of Electrolyzers  
Source: NEL

# 6

potential locations to produce hydrogen within Moray

Based on the demand profile it would be feasible to reach the capacities required in the short, medium and long term by installing multiple identical blocks in gradual steps up to 2045 and beyond.

Connecting an electrolyser directly to the power output cable from a wind farm, known as direct wire, or alternatively connecting to a substation linked to a wind farm could have economic benefits. The wind farm may produce excess power that cannot be transmitted by the grid network due to constraints or is not required by the grid network due to low power demand. This excess power could be offered to a local user such as a hydrogen producer at a favourable price. A detailed cost benefit analysis will be required to evaluate the viability and will depend on the commercial terms agreed with the suppliers of the electricity.

Further work is required to identify partners from the offshore wind farms to support hydrogen production within Moray.

Other potential sites for producing hydrogen can be considered for the medium and long term to take advantage of increasing hydrogen demand and access to higher capacity wind power. Two examples are shown below:



### 6.3.1 East of Portsoy

The 1000 MW Caledonia offshore wind farm is currently under development and is expected to enter operation in 2028. It is likely that the power cables will be routed to land at a location to the east of Portsoy. The cables from the proposed offshore wind farm cannot cross the Moray East offshore wind farm and therefore will need to come onshore to the east of Portsoy.

Excess power capacity could be used for the benefit of Moray by siting an electrolyser close to the power source or by transmitting power back to Moray using a dedicated cable or the existing grid network. Further analysis on the economic benefits including defining the potential commercial terms with the operator is recommended.

### 6.3.2 Blackhillock

The Blackhillock substation is the largest in Scotland and has access to power from renewable sources as well as national generators via the national power grid. For example, the 588 MW Beatrice Wind Farm delivers its electricity into this substation. Blackhillock is also a suitable location for distributing hydrogen using tube trailers or a new pipeline network to nearby industrial users and the wider transport network within Moray.

There are also social benefits associated with investing in the Blackhillock area including the creation of jobs. With its proximity to Keith, it offers the opportunity for development of this area to be the renewable hub of Moray.

## 6.4 Long Term Hydrogen Production Locations

In the long term – i.e. 2040 and beyond, the existing electrolysers in Moray can be expanded further to meet increasing demand, and it should also be possible to bring in hydrogen from suppliers outside of Moray via tube trailer road transport, a new pipeline network or by repurposing the existing gas distribution network.

The maps on the next 2 pages (Figure 6.2 and Figure 6.3) present both the short-term and medium/long term demand scenarios, illustrating renewable energy and grid supply sources, end users (distilleries and potential HRS locations), the existing natural gas infrastructure network and potential electrolyser locations.



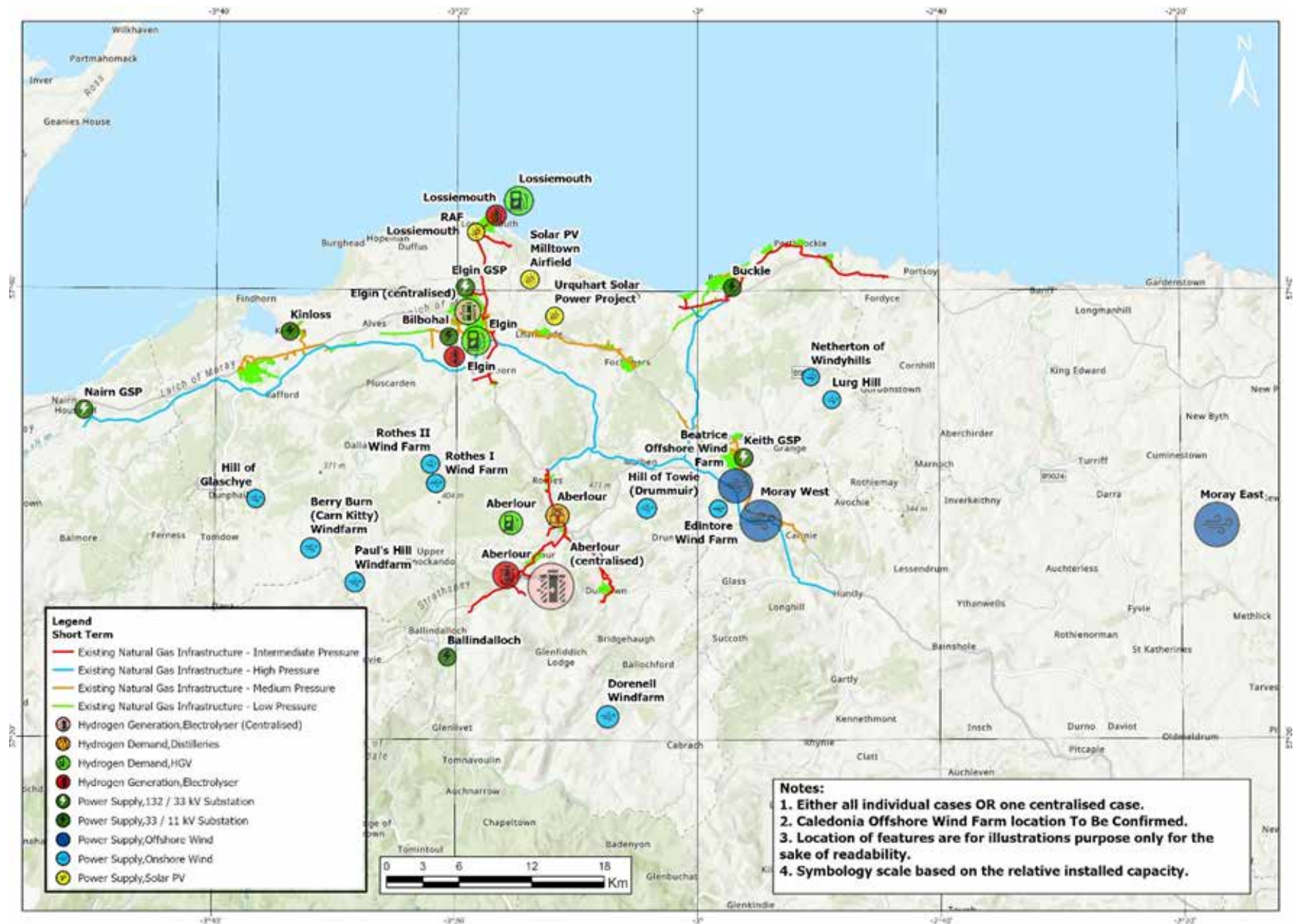

Figure 6.2: Potential Short-Term Production Sites

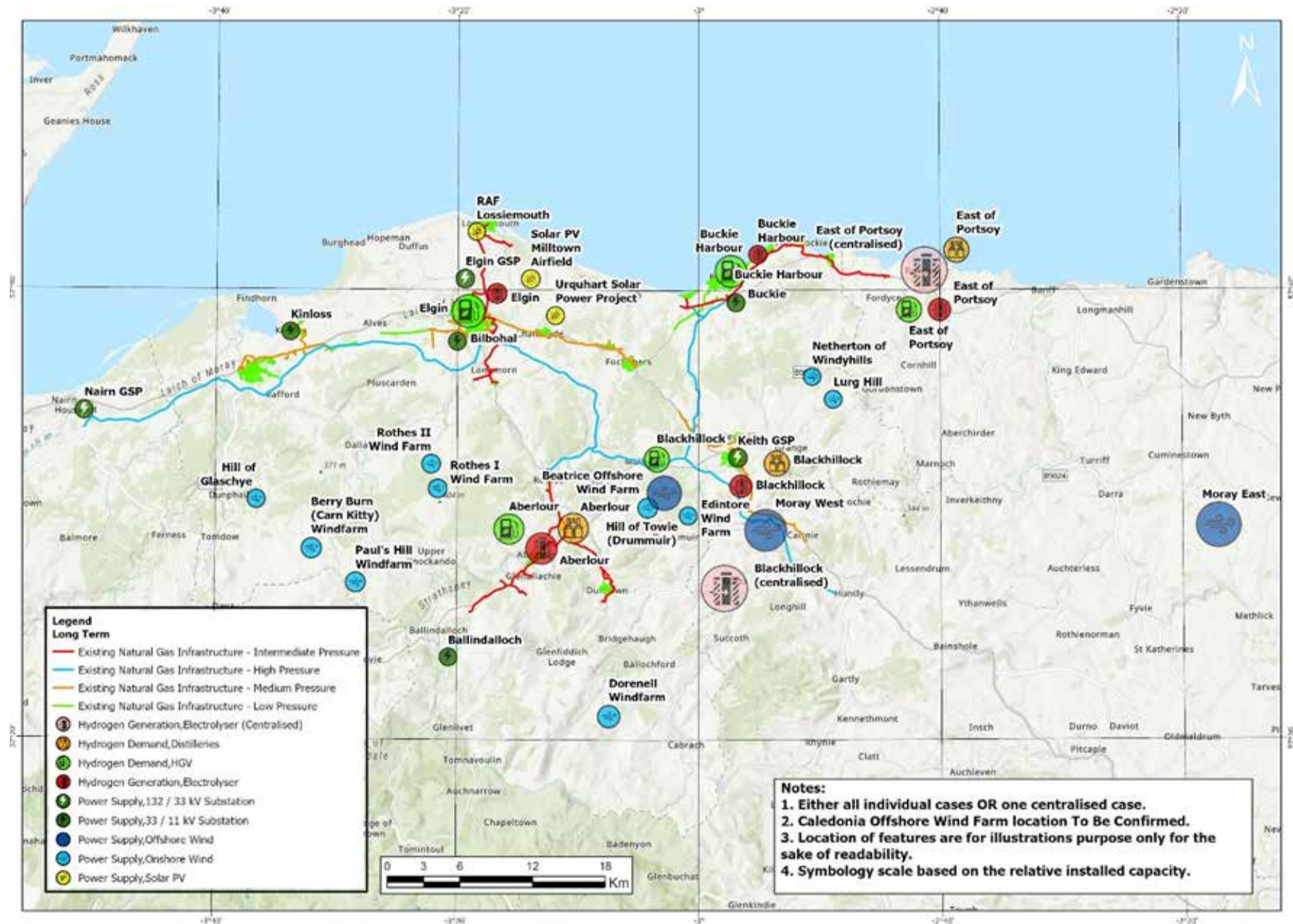

Figure 6.3: Potential Medium/Long Term Scenario

## 7. Gas Network Infrastructure

The economic distribution of hydrogen throughout Moray is key to developing a long-term viable hydrogen economy. A pipeline network is the most effective method for the distribution of large volumes of hydrogen to the industrial and domestic users within Moray. This can be achieved by installing a new hydrogen pipeline network or repurposing the existing gas network for hydrogen.



## 7.1 Introduction

The “Draft Hydrogen Action Plan”, published by the Scottish Government on 10th November 2020 includes the following statement:



We will support initial action by SGN on their pathway to converting large segments of their network to 100% hydrogen, wherever those actions are commensurate with keeping options open and limiting consumer costs.

Also, the Scottish Government’s “A vision for Scotland’s electricity and gas networks” published 12th March 2019 includes the following statement:

“Our vision: By 2030... gas networks remain a vital and flexible component of Scotland’s national infrastructure, delivering affordable energy for heating our homes and businesses. The energy resource carried by the networks will be lower carbon than it is today. The policy, regulatory and technical developments will have been put in place to allow natural and low carbon gas to be blended in the networks, including a contribution from hydrogen.

We will also understand clearly the feasibility and costs of repurposing the gas networks to carry 100% hydrogen and will have made strategic decisions about the long-term role of the networks and the wider decarbonisation of heat.”

The gas network in Moray can be split into its pressure tiers, High Pressure (above 7 barg), Intermediate Pressure (between 7 and 2 barg), Medium Pressure (between 2 barg and 75 mbarg) and Low Pressure (75 mbarg and below). The existing gas network is examined and the considerations for each pressure tier as broken down above when converting the network from natural gas to hydrogen.



## 7.2 Existing Gas Network

The existing gas network in the area consists of a DN250 High Pressure (HP) pipeline that forms the backbone of the local transmission system in the area. There are two HP offtakes that run to Buckie and Rothes where there are pressure reduction stations that reduce the pressure from HP to Intermediate Pressure (IP) and supply the local towns and villages as well as the local distilleries.

In addition to the two HP offtakes there are pressure reduction stations along the pipeline at Coachford (which also supplies Keith), Elgin (which also supplies Lossiemouth, Lhanbryde, Fochabers and Fogwatt) and Forres (which also supplies Kinloss and Kinloss Barracks).

A simplified diagram of the gas network is shown below in Figure 7.1 which excludes the distilleries that are predominantly fed via the IP pipeline downstream of the HP/IP PRS near Rothes.

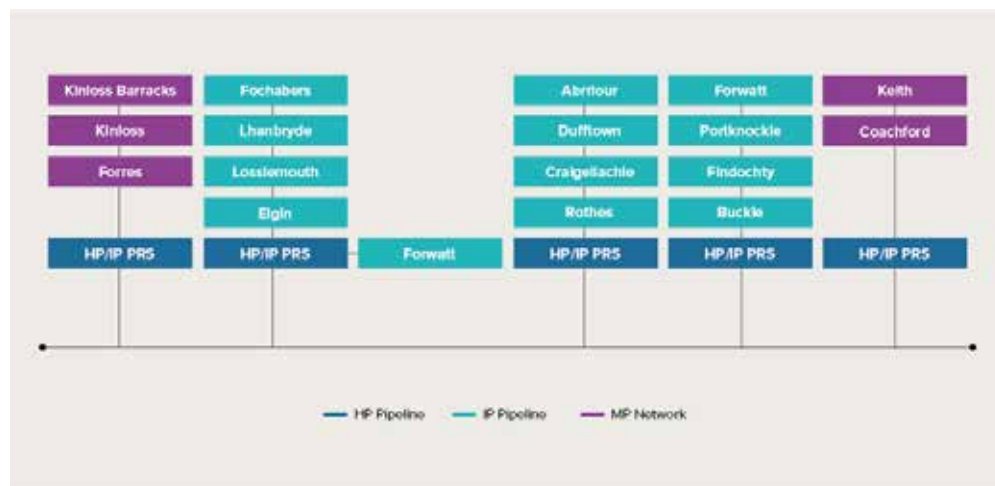

Figure 7.1: Existing Gas Network Excluding Industrial Users  
Source: Mott MacDonald



### 7.3 High Pressure Network

The HP gas infrastructure in Moray consists of the primary DN250 pipeline that supplies the local IP and Low Pressure (LP) gas networks and five pressure reduction stations along the pipeline.



#### 7.3.1 High Pressure Pipeline

The primary HP pipeline is 250mm nominal diameter and the supplies to Rothes and Buckie are 250 and 200mm respectively. The age and condition of the HP pipelines are unknown; however, research undertaken to date has shown that steel transmission pipelines are generally suitable for hydrogen service and as the pipeline is likely to be constructed from L360 grade steel pipe it is likely to be suitable for hydrogen service.



#### 7.3.2 HP Pressure Reduction Stations

There are 2x HP-IP pressure reduction stations at Rothes and Buckie and 1x HP-MP pressure reduction station at Coachford. The equipment on all 3 pressure reduction stations will be very similar and contain the following typical equipment:

- Filters – Filters are used to remove any dust or particles within the gas stream before the pressure is reduced.
- Pre-Heat – To heat the gas prior to pressure reduction where the gas temperature drops due to the Joule-Thompson effect. Pre heating the gas ensures that regulators do not freeze.
- Regulators – To reduce the pressure of the gas from transmission pressure of around 70bar to IP or MP for local transmission.
- Meters – Meters may be installed at the pressure to allow understanding of the gas flows and support network analysis by the gas network owner. The meters are non-fiscal.

The performance and suitability of the existing equipment on pressure reduction stations has not yet been fully researched however initial findings indicate the following:

- Filters – Filters are generally expected to be acceptable however seals are likely to need replacement.
- Pre-Heat – Hydrogen will not require pre-heat as it exhibits a reverse Joule-Thomson effect meaning that its temperature increases during pressure reduction rather than reducing as is the case for most gasses including methane.
- Regulators - Pressure regulators are likely to be generally suitable however the associated control systems will need replacement.
- Meters – Meters are expected to require replacement as they will be unsuitable for hydrogen however depending on the meter type it may be possible to modify the existing meters.



### 7.3.3 Challenges & Next Steps

The HP system at Moray is relatively simple however this creates a challenge when converting the network to hydrogen as there is a single HP pipeline that feeds the area and when converted to hydrogen all downstream users would also need to be converted which would not be possible without a considerable disruption to supply. It will also be necessary for the gas network operator to undertake network analysis to determine if the existing pipelines and pressure reduction installations would have sufficient capacity as the relatively low calorific value of hydrogen compared to methane will require around 3 times the flow to provide the same energy.

It is highly likely that a parallel Local Transmission System (LTS) for hydrogen will need to be installed to allow gradual conversion of discrete areas and end users to hydrogen to avoid disruption of supply. To allow this, a new HP hydrogen pipeline and associated pressure reduction stations would be installed, and both the existing and new HP systems ran in parallel during the conversion process. Installing a new LTS network in Moray would also allow the network to be correctly sized for the expected hydrogen flows rather than rely on existing infrastructure.



Work is currently underway by the gas networks to determine the most suitable means of converting the network to hydrogen including studies to determine the number of end users that can be converted at one time and if a parallel LTS will be required. It is recommended that once this work has been completed by the networks the findings are applied to Moray to determine the extent of new infrastructure that will be required.

### 7.4 Intermediate Pressure Network

The IP network primarily supplies gas to the local towns and villages as well as the industrial end users (e.g. distilleries). There are three main IP systems which are supplied by the HP/IP pressure regulating installations located south of Buckie, adjacent to Inchgower Distillery, North of Rothes and Southeast of Elgin. The 3 gas networks have a single point of supply and are linear in nature but will incorporate isolation valves to allow sectionalisation of the network which may aid conversion to hydrogen.

The IP pipelines fed from the three HP/IP pressure reduction stations feed the majority of the local domestic and industrial users and include a number of IP/LP district governors which reduce the pressure to 75 mbar.

#### 7.4.1 Intermediate Pressure Pipelines

The IP network will be constructed from PSL 2 Grade L245 or B steel pipe or PE100 SDR 11 polyethylene (PE) pipe. PSL 2 Grade L245 and B steel pipe have been found to be suitable for hydrogen as they are more ductile grades of steel so have been found to be less susceptible to embrittlement. PE pipe has also been found to be suitable for hydrogen usage therefore repurposing the IP pipework for hydrogen is not expected to be an issue.

#### 7.4.2 IP Pressure Reduction Stations

IP pressure reduction stations are far smaller and simpler than HP pressure reduction due to the smaller pressure drop and flows and are normally small skid mounted district governor modules contained within GRP kiosks. Similar to the HP pressure reduction stations, the IP/LP governors will contain filters and regulators but due to the small pressure drop (7 bar to 75mbar) no pre-heat system is required as the temperature drop is only 3.5 °C.

Research on the suitability of the district governors is ongoing however current findings indicate that they will not be suitable for hydrogen due to the compatibility of certain materials within the key components. Due to the relatively low cost and ease of replacement it is expected that district governors will be replaced as part of a hydrogen conversion strategy.



### 7.4.3 Challenges & Next Steps

The key challenge with the conversion of the IP network is similar to the HP network regarding the number of end users that would need to be converted at one time when each of the IP mains was decommissioned and re-commissioned with hydrogen. The IP pipeline fed from the HP/IP pressure reduction station south of Buckie for example supplies Buckie, Findochty, Porknockie, and Fogwatt. When the IP main is converted it will be necessary to purge all downstream pipework on the network up to the domestic appliances then undertake any conversions such as burners changes in appliances before recommissioning gas supplies with hydrogen.

### 7.5 Medium Pressure

There are two main MP networks within Moray, one that feeds Keith and Coachford from a HP/MP pressure reduction station south of Coachford and a second that supplies Forres, Kinloss and Kinloss Barracks from a pressure reduction station south of Kinloss. There are also two small MP networks that are fed from the IP network that feed parts of Elgin, Lhanbryde, Mosstodloch and Fochabers.

#### 7.5.1 Medium Pressure Pipeline

MP pipelines are generally constructed from various grades of PE pipe which is suitable for hydrogen usage. Depending on the age of the networks, historic materials such as ductile iron pipe which was introduced in the 1970s may be present; however, the gas networks have been undertaking mains replacement schemes to ensure that these have been replaced with PE and the works will be complete prior to hydrogen conversion.



#### 7.5.2 MP Pressure Reduction Equipment

MP pressure reduction equipment (district governors) are similar to IP governors and have the same issues and challenges. As with IP governors it is likely that they will be replaced as part of any hydrogen conversion.

#### 7.5.3 Challenges & Next Steps

The MP networks supply significantly less consumers therefore it may be possible to assess the networks and undertake the conversion of the four MP networks within an acceptable outage period. It is recommended that when the overall network design is undertaken the requirement for the existing MP network is assessed as it may be possible to optimise the network to reduce the number of pressure reduction stations.

### 7.6 Low Pressure

The LP network consists of the local pipework that supplies the domestic and some commercial end users. The LP network will be suitable for hydrogen as again polyethylene pipe is used. The LP pipework and domestic supplies will be suitable for hydrogen and the network should be able to be isolated as necessary to allow sections of the network to be converted to hydrogen at a manageable conversion rate.

## 7.7 Future Hydrogen Network

After analysing the Moray gas network model, it is highly likely that a new hydrogen network would look very similar to the existing natural gas network. The routing of existing pipelines has taken advantage of favourable topography so similar routes are expected to be followed for a new network. Due to the dispersed nature of the dwellings not supplied by the existing gas network it's unlikely to be economic to try to expand the network to encompass additional areas.

To ensure that the new gas network is suitably sized it will be necessary for the network operator (SGN) to undertake a network analysis based on the current gas demand to ensure that both the new network and any pipework to be repurposed for hydrogen on any pressure tier is suitably sized for the increased flows of hydrogen.

### 7.7.1 Hydrogen Source

Large quantities of blue hydrogen are assumed to be the main hydrogen source during the transition from natural gas due to the requirement for security of supply and intermittency of green hydrogen. Blue hydrogen is generated from natural gas sources where the carbon dioxide by-product is captured and stored to prevent release to the atmosphere. It is likely that blue hydrogen will be produced at or near to the St Fergus terminal and therefore a single feed of hydrogen similar to the existing natural gas supply will be the primary source. As green hydrogen sources come online which may require additional pipelines for them to feed into the gas network additional opportunities may become available to extend the network organically and add additional users onto the gas network.

### 7.7.2 Potential to Expand the Gas Network

The use of alternative routes for the necessary parallel HP and IP hydrogen networks could be considered to encompass additional areas. If the new infrastructure was designed to tie into the end of the existing network, it may be possible to convert the existing network in smaller manageable sections (for example install a new HP pipeline to Fochabers rather than Elgin then convert from Fochabers to Elgin in sections). This approach would require suitable pipeline routes and may be considerably more expensive than following the existing infrastructure with little advantage unless a significant number of additional consumers were found.



## 8. Economic and Funding Analysis

A high-level economic analysis has been undertaken to provide an indicative range of the cost of hydrogen production of the proposed supply options. The analysis is based on Levelised Cost of Hydrogen (LCOH) methodology which is widely applied in industry.



### 8.1 Levelised Cost of Hydrogen Calculation

LCOH is the discounted lifetime cost of building and operating the asset, expressed as a cost per energy unit of hydrogen produced (£/kg of H<sub>2</sub>).

LCOH is defined as the Net present value of the total life cycle cost divided by the Net present value of the total lifetime hydrogen production

A number of economic and technical assumptions have been made to standardise the various parameters used in the analysis, including:

- We assume an operating life of 20 years
- A discount rate assumption of 5% has been applied to derive the costs and production net present values (NPV)
- All values are expressed in real 2022 money. No inflation has been added to numerator or denominator of the LCOH calculation
- An electrolyser efficiency is assumed at 68%
- The electricity utilisation factors are as provided in Table 8.1. No stack replacement, decommissioning or power connection costs have been included.

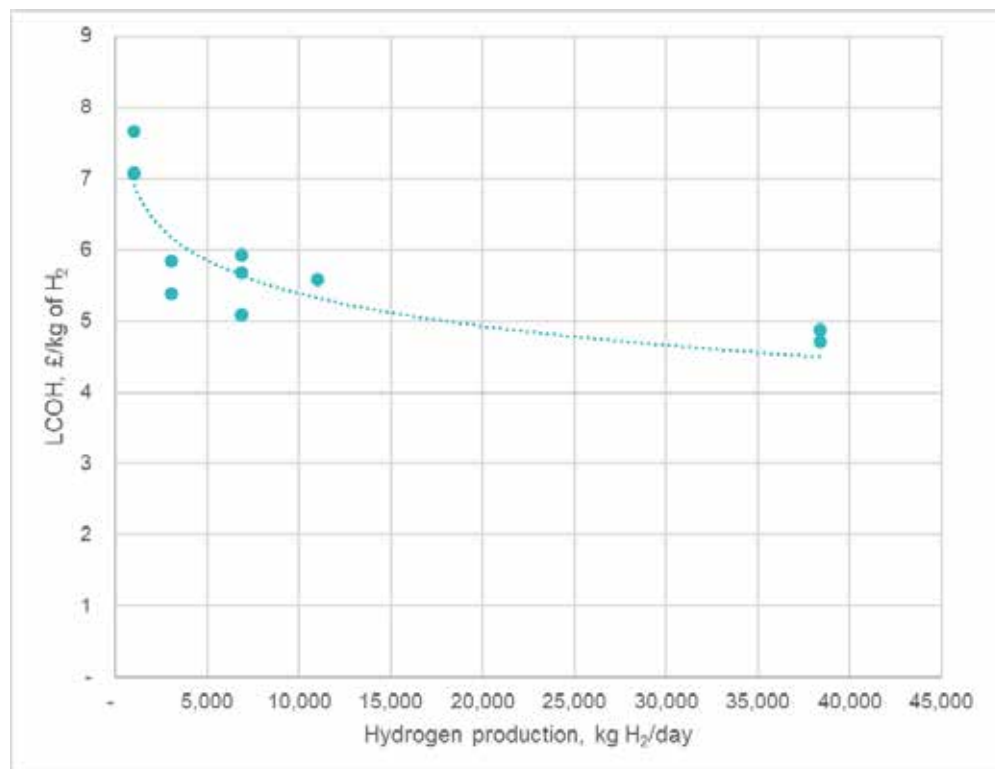

Figure 8.1: LCOH of the supply options

The project life cycle costs include the capital and operating costs described below. A chart on the left summarises the results of the LCOH runs for the supply options. This shows an approximate range is £4.6 - £7.1 per kg of H<sub>2</sub>. The LCOH tends to be lower in the options with the larger size of the production due to the economies of scale based on the electrolyser specific capex and the fixed operating costs dilution. Also, the differences in the LCOH are also impacted by other capital costs, such as hydrogen distribution costs, and the electricity costs.

The levelised costs of hydrogen estimated in this analysis are significantly higher than the competing fuels. Converting on a high heating value the LCOH numbers work out at £117-180/MWh versus average industrial gas price for the last 5 years to Q2:2021 was under £30/MWh. Adding on the carbon cost of £80/tonne CO<sub>2</sub> would raise uplift the gas numbers by £16/MWh.

Current gas prices have not been considered as these have been impacted by the post covid commodity boom and latterly the Ukraine war and the expectation is that gas prices will come down after more normal conditions are resumed probably by 2025. The most recent quarterly data shows gas prices of about £40/MWh, with the expectation of £50/MWh being reached in 2022.

Given the high costs of hydrogen it is unlikely that any of these projects would be commercially viable without support in the foreseeable future, without some public financial support or guaranteed off-take. The Government has proposed that the Contract for Difference (CfD) support mechanism be implement for clean hydrogen projects and in now working with industry to structure the arrangements. This is likely to be a two-way CfD like those applied to renewable generation projects.



Under this scheme the hydrogen producer will be guaranteed a fixed price (possibly indexed to inflation) called the strike price. In this case the reference price (representing the market price) will be set by the natural gas price with the appropriate carbon uplift. When the strike price is above the reference price the hydrogen producer will receive a top up (positive difference) payment, while in the unlikely event of the strike price being below the reference price the difference payment will flow from the hydrogen producer to the offtaker.

Given the need for substantial public support, these arrangements will be only allocated by government, probably via some tender mechanism. The initial allocations are scheduled for 2023/24.

There are other support options. It is possible that in some high value market sectors, such as clean transport fuels, a combination of grant funding and other special treatment would allow a dedicated hydrogen production and filling station project to become commercially viable.

### 8.2 Project Capital Costs

A concept level Class 5 cost estimate has been provided in accordance with AACE 18R-97: Cost Estimate Classification System, as applied in Engineering, Procurement, and Construction for the Process Industries. Typical accuracy ranges for Class 5 estimates are -20% to -50% on the low side, and +30% to +100% on the high side, depending on the technological complexity of the project.

Electrolyser Size MWe	Cost Estimate (Electrolyser and Storage)	Notes
2.3	£3.7m	Pilot project, suitable for Lossiemouth, Aberlour, Buckie, and Elgin.
65	£82m	
130	£134m	
300	£339m	Potential long term hydrogen production in Moray.

Table 8.1: Order of Magnitude Cost



### 8.3 Project Operating Costs

The largest component the operating costs is the power supply. Table 8.2 below shows the assumed power utilisation factors and delivered costs assumptions based on the “ballpark” estimates for on-shore, off-shore and grid supply options. The power utilisation factors include downtime for electrolyser maintenance. And the power delivered costs are as seen in similar projects based on long term supply contracts.

Other variable operating costs, that include water supply, are assumed at £1/MWh for all of the options.

The Fixed operating costs are assumed at 2.5% of the upfront capital costs per annum.

#### Additional Costs:

- A 1000Kg / day Hydrogen Refuelling Station will cost approximately £1.6m per station.
- Tube trailer loading facilities for the distribution of hydrogen, including tube trailers will cost approximately £3.6m.

#### Exclusions and assumptions:

- It is assumed that tube trailer haulage, if required, will be provided by a haulage company
- Owner’s costs have been excluded
- Contingency has been excluded
- Licence Fees has been excluded
- Import Duties has been excluded
- Taxes has been excluded
- Insurance has been excluded
- Escalation has been excluded

Power Supply	Utilisation Factor	Delivered Costs, £/ MWh
On-Shore Wind	35%	50
Off-Shore Wind	50%	55
Grid	100%	70

Table 8.2: Power Supply Costs

## 8.4 Government Policy and Funding Mechanisms

Government funding and resources may be available to support hydrogen projects and technologies, such as the initiatives proposed for Moray.

### 8.4.1 Just Transition

The report published by the Just Transition Commission “A national mission for a fairer, greener Scotland”, published 23rd March 2021, provides recommendations to the Scottish Government on the actions required to transition to net zero ensuring climate action, fairness and opportunity are delivered to the communities in Scotland. The initial response by the Scottish Government “Just Transition” published 7th September 2021 covers the 4 key messages:

1. Planning for a managed transition;
2. Equipping people with the knowledge and skills they need, while putting in place safety nets to ensure no-one is left behind;
3. Involving those who will be impacted: co-design and collaboration; and
4. Spreading the benefits of the transition widely, while making sure the costs do not burden those least able to pay.

Source: Just Transition, A Fairer, Greener Scotland  
www.gov.scot

### 8.4.2 Green Jobs Fund

A £100 million Green Jobs fund is intended to support new and increased job opportunities for green job creation across Scotland. The strategy for net zero transition and introducing a hydrogen economy in Moray could be eligible for funding support.

### 8.4.3 Hydrogen Action Plan

The “Hydrogen Action Plan, Draft”, published 10th November 2021 by the Scottish Government sets out key actions during the next 5 years for the development of a hydrogen economy in Scotland, as defined in “The Hydrogen Policy Statement” published in December 2020.

The Hydrogen Action Plan identifies key areas of Scottish Government funding where resources may be available to support hydrogen projects and technologies.

A selection of the funds that may be applicable for supporting the introduction of a hydrogen economy in Moray are provided in the table below:

Fund	Value	Notes
Just Transition Fund	£500m	For North East Scotland and Moray
Energy Transition Fund	£62m	
Energy Technologies Fund (Hydrogen)	£100m	
Scottish Zero Emission Bus Challenge Fund	£50m	
Low-Carbon Manufacturing Challenge Fund	£50m	
Green Growth Accelerators Programme (local authorities)	£200m	Public and private investment
Green Jobs Fund (Enterprise Agencies)	£100m	As mentioned above

Table 8.3: Available Funds to support a Hydrogen Economy



### 8.4.4 Climate Change Plan

The “Update to the Climate Change Plan 1028-2032” published 16th December 2020 by the Scottish Government also identifies several potential funding sources applicable to the hydrogen economy within Moray, some of these have been mentioned above.

### 8.4.5 The Net Zero Hydrogen Fund

The Net Zero Hydrogen Fund opened April 2022, by the Department for Business Energy and Industrial Strategy, has a value of £240m and may also provide development funding costs for the proposed Moray hydrogen generators.

### 8.5 Gross Value Added (GVA)

The development of a hydrogen economy within Moray will bring many benefits to the region including inward investment, creation of new opportunities and jobs, retention and development of young persons in Moray. Inward investment in the hydrogen supply, demand and infrastructure within Moray offers a sustainable economic growth opportunity with a positive impact on reducing poverty.

Moray will be able to take advantage of opportunities for economic growth across the whole hydrogen value chain:



- **Production:** Moray has access to significant sources of renewable energy including onshore and offshore wind and has access to the national electricity grid infrastructure. Power is available to start producing hydrogen in Moray using electrolysis and to scale up as the hydrogen economy grows.

- **Storage:** Hydrogen storage will be required at the hydrogen production sites, the hydrogen refuelling stations and at the industrial users' sites. The provision of these facilities will bring inward investment into the Moray area.



- **Downstream Users:** The immediate demand for hydrogen is predicted to come from HGVs starting with “back to base” vehicles such as buses and council refuse trucks. Moving towards the year 2030 and beyond, the availability of large hydrogen powered HGVs (using hydrogen fuel cells or hydrogen fuelled internal combustion engines) will support the growth in the hydrogen powered haulage sector in Moray. Moray is well placed to develop an economy based on green road transportation with the existing haulage companies based in Moray and its position on the A96 and A95/A9 corridors.

Scaling up hydrogen solutions in the UK could unlock £18bn in GVA and 75,000 jobs by 2035. The community in Moray can benefit from this investment and grow the hydrogen economy.

- **Transmission and Distribution:** In the short-term hydrogen can be generated close to the end users and therefore a transport network is not required. In the medium and long term, infrastructure will be required for road-based hydrogen transportation by tube trailer and also pipeline distribution that could include repurposing the existing gas network within Moray.



## 8.6 Additional Revenue Streams

### 8.6.1 Waste Heat Integration

The electrolysers produce a significant amount of waste heat. Instead of simply removing this through the cooling water system, some of this heat can be utilised for district heating, agriculture (greenhouses), industrial space heating or low temperature process heating/drying.

It should be noted that a cooling water system would still be required to balance the seasonal changes in the hot water demand for the district heating system.

Integration with a district heating system would potentially provide an additional revenue for the project. However, the cost of constructing a new local district heating system and the infrastructure to circulate the hot water, would be significant and the economic viability would need to be evaluated.



### 8.6.2 Oxygen

Oxygen is a by-product of the hydrogen production process; it also has a significant commercial value. Providing oxygen to nearby consumers by pipeline or as compressed gas would provide an additional revenue for the project. However, this again must be balanced against the cost of the additional infrastructure required to process the oxygen.

Oxygen is widely used in industrial, medical, and scientific applications, generally to improve the efficiency for the following processes:

- Combustion
- Oxidation
- Fermentation
- Oxygenation

Some typical consumers and applications of oxygen are:

- **Steel production** (combustion in furnaces)
- **Welding** (combustion in oxy-welders)
- **Power generation** (oxy-fuel combustion)
- **Oil refining** (combustion in FCC & SRU)
- **Automotive and transportation** (combustion in laser cutting equipment)
- **Glass and ceramics production** (combustion in furnaces)
- **Aerospace and aircraft** (in liquid-fuelled rockets) (combustion in engines)
- **Minerals refining** (oxidation)
- **Water treatment** (aerobic fermentation)
- **Manufacture of medicines** (fermentation)
- **Health care** (oxygenation)
- **Fish farming** (oxygenation)
- **Breathing apparatus** (e.g. underwater work, chemical plant) (oxygenation)
- **Pulp / paper industry** (delignification, combustion, oxidation)
- **Biotechnology** (oxygenation for cell growth)
- **Syngas production / gasification** (partial oxidation)
- **Food industry** (shielding gas for food preservation)

## 9. Social Benefits

Moray is considered a natural location to establish a Hydrogen economy and develop wider green technologies to support Scotland's renewable energy supply chain. There are significant opportunities to generate local community benefits in relation to social, economic, and environmental wellbeing.

These in the main align with recognised benefits associated with the green transition, including reduced carbon emissions, long-term generation of high-quality, well-paid jobs, upskilling the local workforce in high growth areas against skills shortages, opportunities to attract inward investment, increased diversity and competition in local markets, and the overall improvement of community cohesion and wellbeing.



This report provides an overview of the potential community benefits that could be achievable through the development of a Hydrogen economy within Moray. There are significant opportunities for embedding and maximising community benefits throughout the lifecycle and development of projects that will form part of the Moray Hydrogen Economy. These include the scoping, design, construction, and in-use phases.

This section of the report focuses on the high-level potential community benefits; however, specific advice can be provided on how best to realise benefits through the various phase of the development - design, procurement, construction, commissioning and in-use.

Momentum is building internationally for hydrogen to play a key role in a future decarbonised energy system. Within Europe and globally, nations are developing hydrogen strategies and policy frameworks, to set out their national ambitions.

Scotland's vast renewable resources, combined with its skills and supply chain focused on energy transition, are "critical to establishing a prominent role for Scotland in the emerging global hydrogen market"<sup>2</sup>. Owing to the localised nature of green hydrogen energy resources and associated infrastructure, proposed schemes will need to be designed in alignment with Moray's specific geography, resources and communities.

### 9.1 Moray – Local Context

Moray has an estimated population of 95,700 of which 61.2% are of working age (below both Scotland, 63.9% and GB, 62.4% averages). 77.4% of the local population are economically active, with 17% of the local workforce in manufacturing, 10% in food and drink manufacturing, and 10% in tourism. Moray has a much larger proportion of skills trade occupations (13.2%) and process plant & machine operatives (10.85%) than Scotland and GB averages. The regional unemployment rate is lower in Moray than in Scotland and GB, but there is a marked increase in unemployment within 16-24 age category. Reporting shows a key barrier to employment in the region is a disparity between young people and employers' perceptions of entering the world of work. Specific barriers for young people being cited as anxiety & confidence issues (23%), need for previous experience (22%), discrimination on age, gender, or race (11%), health conditions (10%), and lack of local opportunities (10%)<sup>3</sup>.



Approximately 300 business start each year in Moray, with a high proportion of micro and SME-businesses being based in the region. Perhaps owing to its unique health ecosystem, Moray is emerging as a prime location in research and development for the life science, digital and technology sectors. With a number of purpose-built business parks located at Elgin and Forres that are home to thriving local businesses such as Hunter Cow, IT Central, Fibre 1, Orbex and Biomatrix Water Solutions.

The area has a growing reputation in developing digital and online technologies to improve service delivery and efficiency. There is a cluster and critical mass of activity along the A96 Inverness to Elgin "corridor", which comprises 40+ organisations including, NGOs, health boards, academia, and commercial companies. The Digital Health Innovation Centre is one of the first organisations to benefit from a £5million Moray Growth Deal to deliver a Rural Centre of Excellence for Digital Health and Care Innovation. Moray is considered a natural location to establish an engineering business to support diversification into the renewable energy supply chains, supported by an increasingly digitally capable and technically skilled workforce.

<sup>2</sup> Scottish hydrogen: assessment report - gov.scot ([www.gov.scot](http://www.gov.scot))

<sup>3</sup> DYW-Positive-Futures-Survey.pdf ([dywmoray.co.uk](http://dywmoray.co.uk))

When understanding and contextualising the potential opportunities and benefits identified in relation to increasing hydrogen capacity in the region, the following local social, economic, and environmental wellbeing themes should be considered (Table 9.1):

Theme	Challenge	Description
Social	Access to Services	There are above average percentages of older people within Moray, particularly in more rural and coastal areas which creates challenges in relation to service delivery & access, and social isolation. These groups are also more vulnerable to fuel poverty, owing to recognised differences in quality and quantity of housing stock.
Social	Education	There is a variation in outcome for young people in Moray in relation to attainment and post-school destination, which impacts on their choices for their future. Only 61.2% of pupils leave school with one or more SCQF level 6 or 7 (Scotland average, 68.2%), and it is noted that the Moray economy does not provide a good match for young people's career aspirations: energy, financial services and life sciences.
Social	Skills	Moray's Local Outcome Improvement Plan reports that there is a mismatch between school leavers' career aspirations and the local job market and that gender inequality is a significant challenge in work <sup>4</sup> . This lack of local opportunities may explain the lower proportions of young people, and particularly young women, in Moray. Young people are more likely to aspire to leave Moray than to stay - 45% compared to 40% for Highlands and Islands <sup>5</sup> .
Social	Equality	Moray has the fifth biggest pay gap between male and female residents in Scotland at 12.4% – trailing only behind Shetland within the Highlands and islands <sup>6</sup> . As such, there is a regional need and aspirations to increase opportunities for young boys and girls in diverse fields as part of growth planning.
Economic	Economic Diversity	Moray's economy is founded primarily in manufacturing (17.1% employment vs Scotland av. 7.4%), with a focus on the food and drink (11% employment vs Scotland av. 1.7%), agriculture and tourism sectors (10% employment) <sup>7</sup> . The presence of two large defence establishments at RAF Lossiemouth and Kinloss Barracks also creates employment opportunities for the area. This heavy reliance on a limited number of sectors means the region is disproportionately at risk from local, national and global market changes within this sector for economic sustainability and associated employment. <sup>8</sup>
Economic	Business Growth	Moray has smaller businesses and slower rates of business growth than the national average. Micro enterprises with less than 10 employees form 88% of all Moray businesses. The rural nature of the geographic location and competition from the more urban parts of Scotland poses a challenge to attracting inward business investment.
Economic	Quality of Work	Moray has relatively high employment rates in mainly low paid and low skilled industries with seasonal work common (over 1/5 of employees in Moray earn less than the 'real living wage' <sup>10</sup> ). Weekly wage levels rates lag those of neighbouring authorities and the Scottish average (Moray - £498, National average - £548) <sup>11</sup> . High-quality, well-paid jobs are needed to support local communities and economic growth.
Environment	Fuel Poverty	A household is said to be in fuel poverty if it must spend more than 10% of its income on fuel, to heat their home to a satisfactory level. Latest figures estimate that 34% of households within Moray are in fuel poverty, which is significantly above the Scottish average of 24%. Fuel costs are also recognised as higher within rural areas, which means a significant proportion of Moray's population would benefit from more economically viable alternatives.
Environment	Climate Change	With respect to CO2 emissions within the scope of influence of Local Authorities, as defined by the Department for Business, Energy & Industrial Strategy, per capita emissions of Moray are the highest of any Local Authority in Scotland. This is attributable in large part to industry and commercial emissions per capita, 7.9t CO2 per person, compared to the Scottish average of 4.9t CO2 per person, and more specifically – the consumption of gas. These high relative emissions are assignable to Moray's whisky distilling sector, food producers and two MOD military facilities.

<sup>4</sup> LOIP ([yourmoray.org.uk](http://yourmoray.org.uk))

<sup>5</sup> Understanding poverty in Moray - Poverty Profile (Feb 2018)

<sup>6</sup> Moray vows to reduce gender pay gap as part of city deal funding bid ([pressandjournal.co.uk](http://pressandjournal.co.uk))

<sup>7</sup> Find out about working and jobs in Moray Scotland | MyMoray

<sup>8</sup> [file123287.pdf](http://file123287.pdf) ([moray.gov.uk](http://moray.gov.uk))

<sup>9</sup> [file113295.pdf](http://file113295.pdf) ([yourmoray.org.uk](http://yourmoray.org.uk))

<sup>10</sup> Ibid – Footnote 4

<sup>11</sup> Ibid – Footnote 4

**Table 9.1: Local social, economic, and environmental wellbeing themes to be considered**

## 9.2 Regional Community Benefits of Increasing Hydrogen Capacity

Moray Council has a vision for the region to provide “a life of opportunity for all, where people can thrive in vibrant communities, and where we work together to enrich our future”<sup>12</sup>.

There is a recognition that achieving this vision will require a combined and collaborative approach across public, private, community and voluntary organisations to identify what stakeholder can do together to ensure the local people and places flourishes.

To help achieve this, the following priorities have been set for the region in Moray’s Corporate Plan 2024:

- Our People: To provide opportunities for people to be the best they can be throughout their lives with a strong and sustained focus on those individuals and groups in Moray’s society who experience the most disadvantage and discrimination.
- Our Place: Empower and support communities to build capacity.
- Our Future: Drive economic development to create a vibrant economy for the future.

In line with these priorities, and wider aspirations around providing long-term economic stability for the region, Moray’s Economic Strategy 2019-2024 sets our four outcomes that need to be achieved:

- Qualification Levels: An increase across all ages and genders in qualifications relevant to growth sectors
- Small Business Growth: More small and medium-sized businesses employing between 10 and 100 people
- Talent Attraction, Retention and Return: More skilled, higher paid jobs that deliver net in-migration in the 16-29 age range
- Business competitiveness – An increase in capital investment and focused workforce development to strengthen competitiveness.<sup>13</sup>



When thinking about how development in general across Moray can lead to local positive benefits in relation to social, economic, and environmental wellbeing, we need to understand how identified opportunities and impacts relate to this overarching vision for the region. Table 9.2 below provides an overview of potential community benefits that could be achieved in Moray from developing a local hydrogen economy. Identified benefits from this development for local people and place have been aligned to Moray Council’s priorities<sup>14</sup> to show local relevancy and impact.

<sup>12</sup> Corporate Plan 2024 (moray.gov.uk)

<sup>13</sup> The Moray Economic Strategy - Moray Council

<sup>14</sup> Ibid – Footnote 12

Theme	Benefit	Description
Our People	Employment Opportunities	Developing a hydrogen economy will provide the opportunity to create new, high-quality jobs within Moray in a sector based on sustainable resource management and protection. Not only can this help to alleviate current challenges within Moray around unemployment, but the provision of opportunities within this high-growth, environmentally conscious space may help to attract more young-people to live and stay in Moray.
Our People	Skills Development	Developing Moray's hydrogen capability will help to increase local awareness and access to training and upskilling opportunities related to the green transition. Properly designed and resourced training in the local area can help to address recognised local skills shortages (which have been exacerbated by the pandemic). This will help to generate beneficial outcomes for local businesses from having greater access to relevant talent, and benefits for local people in helping them to access skills and knowledge required to advance their careers (linked to multiplier benefits of increased financial security and wellbeing). Training can also support the transition of skills from local 'brown' industries (e.g., oil and gas) to green industries, equipping them with skills needed to compete for opportunities. It is anticipated that local colleges and training providers will require support in developing new training offering/courses that are specifically related to hydrogen. It is also expected that local colleges are currently unlikely to offer this as a part of their standard teaching offer, and as such, specialist support will be needed to build local knowledge and capacity.
Our People	Decreased Fuel Poverty	A major strength in developing localised energy systems is that the system can be built around the relevant local resource and can closely match and deliver energy to the end user when required. It is also expected that regional development of renewable energy sources will provide more economically viable fuel sources for hard-to-reach areas, reducing current 'pockets' of deprivation seen across many rural areas. Shifting away from fossil fuels is an opportunity to build a fairer and more equal society throughout Moray, that removes existing pockets of deprivation (e.g., rural areas). Increased security and access to fuel is linked to improve mental and physical wellbeing outcomes for residents, helping to support sustainable local communities. It is also recognised that any initial financial cost increase related to the transition from contemporary fuel sources to hydrogen, could be counterbalanced by referenced improved employment opportunities and increased higher wages (wider socio-economic benefits).
Our People	Health	Pollution from burning fossil fuels (coal, oil, gas, diesel) is a contributory factor for asthma and other respiratory diseases. Reducing reliance and usage of said fuels in the region can help to reduce local air quality and pollution risks, better safeguarding the health of residents and visitors and reducing pressures on local health support services. Whilst Moray locally does not suffer from poor air quality, the transition away from fossil-fuel usage aligns to national and international efforts around minimising health impacts as a result of pollution.
Our Place	Community Cohesion	There is the opportunity to enable Moray communities to collaborate with local private and public sector organisations in creating a shared vision for the region. This will enable a smoother transition for individuals and regions through targeted skills and innovation support. For example, stakeholders could explore 'Community funded' or 'Community Ownership' of any potential hydrogen scheme, with revenue-generated funnelled into supporting local people, places, and businesses. Moray council have shown their interest in this approach / model as taken in Huntly. <sup>15</sup> Overall, greater engagement and connection to the scheme may alleviate and minimise challenges associated to the works, founded on a greater regional understanding of the social, economic, and environmental wellbeing benefits associated to the transition.

Table 9.2: Overview of potential community benefits

<sup>14</sup> <http://localenergy.scot/wp-content/uploads/attachments/huntly-hydrogen-cares-case-study.pdf>

Theme	Benefit	Description
Our Place	Community Regeneration	There is also potential for community benefits to arise via future inward investment to the region because of perceived leadership / innovation around hydrogen technologies. In 2021, Tees Valley became the home to the UK's first-ever hydrogen transport hub and received £3m in government funding to kick-start the programme. It is expected that the scheme will create up to 5,000 new jobs in the local area, with pop-up trials proposed for local shops, supermarkets and transport companies to support them in understanding potential benefits from hydrogen technology for powering transport and moving goods <sup>16</sup> . This type of scheme in Moray could attract similar investment and be a catalyst for local business growth and regeneration in the area (linked into wider benefits referenced in this table).
Our Place	Community Regeneration	There is also potential for community benefits to arise via future inward investment to the region because of perceived leadership / innovation around hydrogen technologies. In 2021, Tees Valley became the home to the UK's first-ever hydrogen transport hub and received £3m in government funding to kick-start the programme. It is expected that the scheme will create up to 5,000 new jobs in the local area, with pop-up trials proposed for local shops, supermarkets and transport companies to support them in understanding potential benefits from hydrogen technology for powering transport and moving goods . This type of scheme in Moray could attract similar investment and be a catalyst for local business growth and regeneration in the area (linked into wider benefits referenced in this table).
Our Future	Economic Diversification	Moray's local economy is currently reliant on three key industries. As hydrogen can be produced locally from several sources within Moray (e.g. off-shore and on-shore wind), developing capacity will help to diversity the local market and support the transition to a sustainable, low-carbon economy and related jobs (in high-value areas). It is also recognised that a hydrogen scheme of this nature is likely to bring greater interest from outside investment, supporting and increasing local economic activity.
Our Future	Economic Growth	Investment in hydrogen technology can bring about jobs and continued advancements in every industry touched by it. For Moray, this can help to future-proof existing markets, jobs, and businesses, whilst also providing a new space for local capabilities to develop into. This will help to foster innovation within existing businesses and industry processes, supporting a wider transition within the region to more sustainable and green ways of working. For those local organisations and people engaged with the proposed scheme, owing to the relative infancy of hydrogen technologies globally (but increasing interest), there is the added benefit of being able to position themselves and access opportunities as they develop within domestic and international markets.
Our Future	Supply Chain Growth	There is already significant momentum from both industry and government in hydrogen demonstration and development, supported by a complex network of research and innovation programmes and funding sources. Co-ordination of the proposed development of Moray's capacity with other regional and national programmes across the hydrogen supply chain can support more efficient delivery and increase value for money. This may also give Moray communities and businesses greater access to industry networks and best practice from other schemes, helping to better inform local skills and knowledge development.
Our Future	Regional Collaboration	There is already significant momentum from both industry and government in hydrogen demonstration and development, supported by a complex network of research and innovation programmes and funding sources. Co-ordination of the proposed development of Moray's capacity with other regional and national programmes across the hydrogen supply chain can support more efficient delivery and increase value for money. This may also give Moray communities and businesses greater access to industry networks and best practice from other schemes, helping to better inform local skills and knowledge development.

Table 9.2: Overview of potential community benefits

<sup>16</sup> UK's first ever hydrogen transport hub kick-started by £3 million government investment - GOV.UK ([www.gov.uk](http://www.gov.uk))

### 9.3 Ten Recommendations for Unlocking Community Benefits

The development of a Hydrogen economy within Moray provides a unique opportunity for unlocking and generating community benefits for local communities in line with the challenges and priorities identified in this report.

In line with this, we have identified 10 activities or themes through which any proposed hydrogen scheme should focus on when strategising and designing approaches to community

benefit generation to maximise the relevancy and value of benefits generated in line with local needs.

Where possible, any proposed schemes should look to delivery activities in partnership with local organisations, community groups and existing local initiatives to support efficient and effective delivery of benefits.

Table 9.3 below provides examples of partner organisations Moray Council could engage with to support their community benefit offering against the targeted activities.



Initiative	Description
<p>Careers Awareness and Schools Engagements</p>	<p>Successfully delivering any hydrogen scheme within Moray will require a consistent and diverse pool of talent that can suitably sustain people resource requirements. To ensure there is consistent and sustainable development of local skills and knowledge around Hydrogen, local project teams can look to deliver engagement sessions (e.g., industry insight days, careers talk, project talks, mentoring, CV advice, mock interviews) focused on building awareness and attracting more people to hydrogen careers. This links into supporting local employment, skills, and training opportunities. Alignment to Moray Council’s Skills Pathway, Elgin Careers Centre, Skills Development Scotland, DYW Moray and Moray First can help with engaging schools and defining engagement events.</p>
<p>Work Experience and Internships</p>	<p>Moray struggles with an outward migration trend in young people following completion of education. There is therefore a need to improve local higher education and early-years careers opportunities offering to make Moray a more ‘attractive’ location for young people. The nature of hydrogen schemes (i.e., long-term projects requiring technical skills), provides an excellent springboard for promoting a diverse range of attractive and meaningful employment opportunities. Greater awareness of employment opportunities within hydrogen will help to support continued entry of talent into the sector, helping to address local skills gaps. Existing schemes within Moray that can be engaged with include: DYW Moray, Moray’s Work Experience Placement Entitlement Programme, Moray First, and specific institutions such as Moray College UHI and University of the Highlands and Islands.</p>
<p>Apprenticeships &amp; Graduate Placements</p>	<p>There is high potential for beginner entry level job opportunities to create social benefits through apprenticeships and early-years careers roles as part of any hydrogen scheme. As noted, there is a growing skills base of manufacturing / research and development opportunities within engineering in Moray, and the proposed scheme will feed into this. Any opportunities need to be designed with long-term benefits in mind, ensuring engaged individuals are supported to progress happy and fulfilling careers in the region. Existing schemes within Moray that can be engaged with include: DYW Moray, Skills Development Scotland, and University of the Highlands and Islands.</p>
<p>Local Employment Opportunities</p>	<p>The Healthcare cluster on the A96 corridor shows the potential of Moray to adapt and specialise around a certain skills base in recent years, which can similarly be done with the introduction of a local hydrogen economy. It is important to recognise that local employment opportunities need to be aligned with local re-training / upskilling opportunities to help local individuals transition between industries and/or non-technical to technical roles. Existing schemes within Moray that can be engaged with include Moray’s Employer Recruitment Incentive, Moray Pathways Job Portal, Moray Council’s Employment Support Service, and the local Job Centre Plus.</p>

Table 9.3: Examples of partner organisations



Initiative	Description
Equality, Diversity, Inclusion & Wellbeing	Suitably resourcing the growth of hydrogen skills and talent within Moray will require a diverse range of voices and people. Practices around recruitment, employment, skills, and pay all provide an opportunity to embed principles that reduce barriers for under-represented groups of people with STEM industries (women, UK minority ethnic, disabled persons, military, and care leavers), and ensure all individuals related to the hydrogen economy feel happy and supported in their work. Increased quality of local work environment and opportunities will interest more people in careers within the sector, increasing competition for roles and pushing forward local skills and knowledge development. Existing schemes within Moray that can be engaged with include DYW Moray and Moray's Local Employability Partnership.
Developing Future Talent: Upskilling and Training	Planning the transition from today's workforce in Moray to the future workforce required for the 'green revolution' needs a clear development programme to ensure specialist skills and knowledge are locally available. This includes succession planning to ensure local workers are aware and have access to appropriate re-training opportunities to support their entry into hydrogen-related employment opportunities. This is particularly relevant for local workers currently operating in 'fossil fuel' related careers and roles. Existing schemes within Moray that can be engaged with include: DYW Moray, Moray First, and University of the Highlands and Islands.
Developed Market Awareness	Generally, businesses are not aware of the diverse opportunities related to hydrogen development. Local resourcing of any scheme will require an engaged and competitive local market. Without this, schemes may have to look further afield for supplier and supply chain opportunities, meaning associated community benefits will be felt outside of Moray. Any proposed scheme should look to run a series of general engagements with local businesses (e.g., meet the buyer events) to increase local awareness of hydrogen technologies and associated business opportunities for organisations willing to engage. Existing schemes within Moray that can be engaged with include Moray Chamber of Commerce and Skills Development Scotland.
Local Capacity Building	Increasing awareness within local businesses of the opportunities related to hydrogen is one thing: suitably resourcing and accessing said opportunities is another. Mentoring and upskilling sessions provided by specialists can help to grow local capabilities and skills, keeping benefits from the development within the local economy and groups. Existing schemes within Moray that can be engaged with include Moray Chamber of Commerce and Skills Development Scotland.
Procurement Methods	Any scheme should look to use the procurement process throughout the design, construction, and in-use of any hydrogen programme as an opportunity to embed community benefit requirements within related supply chains. The use of contractual commitments around community benefits performance and delivery can ensure that locally relevant positive impacts and community wealth are generated because of the work, directly in alignment with the local challenges identified in this report. A connected and collaborative approach to community benefits across associated supply chains will support more effective and innovative approaches to social value generation, through increased sharing of knowledge, opportunities, and best practice between stakeholders.
Community Engagement	It is critical that any proposed scheme undertakes a detailed engagement programme with local communities to gain their insight on the scheme and help to ensure community cohesion and acceptance of any proposal. It is important these communication paths are kept open throughout the lifecycle of the project, so project stakeholders can ensure their approach to benefit generation remains aligned with local needs and challenges (as these won't be static). This will ensure maximum relevancy and value of benefits generated, potentially leading to greater community acceptance of any scheme as they will feel supported / benefiting from its local presence. Existing entities within Moray that can be engaged with and provide support as the Hydrogen Economy is developed include tsiMORAY, Moray Council's Essential Skills programme, Volunteer Scotland, MORINFO and Moray Community Centres.

Table 9.3: Examples of partner organisations

## 9.4 Next Steps and Recommendations for Moray

Achieving community benefits for Moray and its people are not inevitable outcomes from developing the hydrogen economy within the region. Due planning, process and systems are needed to ensure that community benefits are considered and embedded throughout the lifecycle of any proposed scheme, if meaningful positive impacts are to be achieved.

In line with this, we have identified 6 key recommendations for how locally relevant community benefits can be maximised through any proposed Hydrogen scheme within the Moray region. The table below outlines key components that could be considered when delivering hydrogen schemes within the region to ensure targeted community benefits can be achieved and maximised, and could be considered when a Community Wealth Building strategy is created.

Consideration	Description
Social Value Charter	Any scheme looking to generate community benefits needs to have clear direction around 'what' community benefits they are trying to deliver, 'why' these are relevant to local challenges within Moray, 'how' they are going to generate community benefits, and 'who' is responsible for delivering these benefits. A social value charter can be used to set a clear and consistent approach to community benefit generation meaning all stakeholders engaged throughout the lifecycle and supply chain of the proposed scheme are all working collaboratively towards shared goals. This will support more efficient and effective delivery of local community benefits, maximising positive impacts in relation to social, economic and environmental wellbeing.
Social Value Delivery Framework	Using a social value delivery framework, such as the model developed by Mott MacDonald, will support the measurement and management of community benefits across the lifecycle of any proposed hydrogen scheme. These types of models typically capture performance data against targets and support the monitoring and reporting process to evidence community benefit deliverables. For any proposed hydrogen scheme, it should be explored how associated frameworks can be aligned to Moray Council and regional objectives around social, economic and environmental priorities, to best show how the scheme is addressing local challenges and creating local benefits.
Monitoring and Measuring performance	Developing and embedding community benefits monitoring tools throughout any proposed hydrogen scheme will be critical for robustly and accurately measuring the positive and negative impacts generated. Measuring should be aligned to specific targets, commitments and KPIs to ensure continued progression of benefits throughout the lifecycle of the hydrogen scheme (including optioneering, design, construction, and in-use). Monitoring tools can also be combined with contractual commitments around community benefits with the supply chain for designing, delivering, and managing the hydrogen scheme to support a more representative understanding of the holistic impact of the scheme on local people and place.
Supply Chain Engagement	<p>It is noted that local businesses to Moray may not be aware of diverse opportunities related to Hydrogen. In line with this, it is recognised that at present, there is likely to be limited market capacity and skills around some of the technical aspects and knowledge required for successfully delivering a hydrogen scheme. Any proposed scheme can look to run meet-the-buyer events / other workshops with local businesses to increase awareness of the scheme and proposals, and the associated benefits to their business. Mentoring and upskilling sessions provided by specialists can also be delivered to help grow local capability and skill, keeping benefits from the development within local economy and associated groups. This support around local skills, training and business will allow for greater access diverse thinking around the scheme, increasing potential opportunities around innovation within the scheme.</p> <p>Monitoring tools can be combined with contractual supplier commitments around community benefits to support more connected and effective approaches to benefits generation. These requirements should be aligned to the local challenges and opportunities outlined in this report to maximise the relevancy of impacts generated. Supply chains are considered a 'multiplier' when it comes to social value generation, increasing the reach and resources available to deliver benefits.</p>
Reporting	Regular reporting around benefits can help to keep stakeholders and suppliers accountable to commitments around benefits generation, ensuring targets are met and opportunities maximised. In relation to Hydrogen schemes, owing to their relative infancy within the UK, robust and evidence-based reporting is critical for maximising wider understanding of the opportunities related to the actual technology and the associated economic, environmental, and social wellbeing benefits highlighted in this report. Reporting can help increase societal understanding and support of related schemes, acting as a catalyst for future investment and research into associated solutions and trial programmes.
Communication and Engagement	Engaging with communities to understand their concerns and gain their insight on the scheme can help to ensure community cohesion with any Hydrogen proposals. It is recognised that generally there are concerns related to the security of hydrogen technologies and any impact there may be on local services. Detailed and consistent engagement with communities around Moray throughout each step of the proposed scheme can help to ease tensions, capture diverse voices, improve delivery against local needs, and maximise the overall ability of the scheme to deliver relevant and beneficial community impacts.

## 9.5 Regional Profile – Moray

### 9.5.1 Social Wellbeing

#### 9.5.1.1 Population

Latest estimates indicate that Moray has a population of around 95,700 with an even split between males and females. Between 1998 and 2020, the population of Moray increased by 10.3% which was the 11th highest percentage change out of the 32-council area of Scotland (national average 7.7%). In terms of overall size, the 45 to 64 age group is currently the largest in the region, with a population of 27,544. In contrast, the 16 to 24 age group was the smallest, with a population of 9,019. However, even with this weighting, the region does have a younger age profile than the regional average (dependency ration of 62.5 and 65.5 respectively). 61% of people within Moray are considered in the ‘working age’ population (16-64), which is lower than the national average (63.9%).

#### 9.5.1.2 Employment

77.4% of Moray’s population are economically active, compared to 76.1% in Scotland and 78.5% in Greater Britain (see Figure 1 for breakdown by occupation). In terms of industries, Moray’s workforce supports a significantly higher proportion of positions within food and drink manufacturing (10% compared to Scotland average of 1.7%). In fact, 8.3% of all those employed in food and drink manufacturing in Scotland work in Moray. This is driven by the fact that there are several food companies headquarters in the region (e.g., Baxters and Walker’s Shortbread) and the largest concentration of whisky distilleries in Scotland (over 55 sites).

In terms of other industries, around 8,000 people are employed in engineering disciplines across the region (including manufacturing, construction, and utilities). Reporting shows that electrical and mechanical engineering skills are highly developed in the local workforce. 17.1% of Moray’s workforce is also employed within manufacturing, which is considerably higher than the Scottish average of 8.1%. A further 10% of the region’s workforce are employed in relation to Tourism. The latest predications show a significant increase of 9% for the local construction sector by 2028.

#### 9.5.1.3 Unemployment

The unemployment rate in Moray increased by 2.2% points between December 2019-20 (latest data), which is slightly below the increase across the region (2.4%) and nationally (2.7%). Importantly, the greatest recent growth in unemployment was seen with youth age groups, with a rate of 7.4% reported at the end of 2020. This was below the highland and Islands (7.8%) and national (8.3%) rates, but still suggests significant barriers for your people wishing to enter the labour market.



# 90.7%

of pupils went on to further or higher education or to gain employment

#### 9.5.1.4 Education

Moray has 45 primary schools and 8 secondary schools and in 2017 Moray Council had responsibility for educating just over 11,900 pupils. In 2016/17 the eight secondary schools produced 928 school leavers. Some 90.7% went on to further or higher education or to gain employment.

### 9.5.1.5 Fuel Poverty

A household is said to be in fuel poverty if it must spend more than 10% of its income on fuel, to heat their home to a satisfactory level. Latest figures estimate that 34% of households within Moray are in fuel poverty, with is significantly above the Scottish average of 24%.



## 9.5.2 Economic Wellbeing

### 9.5.2.1 Economy

Latest figures show a significant drop in GVA within Moray from 2019-20, with a fall in 12.6%. Across Moray, manufacturing (down £118m), Construction (down £31.4m) and whole & retail (down £29.5m) are considered the most at-risk sectors in terms of absolute figures. Both the pandemic and Brexit are seen as key drivers of uncertainty and falling performance across most industries in the area.

# 34%

of households within Moray  
are in fuel poverty

### 9.5.2.2 Business

Moray has a more traditional industrial make up, with smaller businesses, slower business growth, fewer opportunities for young people to go into their preferred sectors and a less developed infrastructure to support business.

The location of Moray and its rural nature has particular consequences for the economic growth of the area. At a national level, the north of Scotland competes with the central belt to attract new business and inward investment. Situated between the Highland and Aberdeen City / Aberdeenshire Council areas, Moray also has competition at a local level from its neighbours. Moray's close proximity to Aberdeen places it at a significant economic disadvantage: Aberdeen being Scotland's third largest city and also the hub of the oil and gas industry.

Approximately 300 new businesses start each year within Moray. Whilst there is a considerably higher share of employment in SMEs than seen nationally (61.7% vs 50.6%), this is also significantly below regional proportions (67.6%).

### 9.5.3 Life Sciences

Moray is emerging as a prime location in research and development for the life science and digital healthcare sector. There are a number of strands of life science activity emerging in Moray. The area has a growing reputation in developing digital and online technologies to improve service delivery and efficiency. Although these strands have emerged independently, they are complementary and have arisen because of the unique health ecosystem which puts Moray in a strong position to develop, pilot and test comprehensive digital healthcare models.

Leading edge digital health solutions are being developed in the Moray area, strengthened by a growing cluster and critical mass of activity along the A96 Inverness to Elgin "corridor", which can now be seen as one of the world's first true digital healthcare clusters. Comprising of more than 40 organisations including, Nongovernment Organisations, health boards, academia and commercial companies such as OpenBrolly, who designs healthcare apps for mobile devices and international IT company Atos, both of which are located at the EPF.

### 9.5.4 Engineering, Production and Manufacturing

Moray is a natural location to establish an engineering business to support the oil and gas and renewable energy sectors. With its long history as an engineering and fabrication base for the oil and gas and distillation industries it is perfectly placed for diversification into the renewable energy supply chains. Electrical and mechanical engineering skills are highly developed in the local workforce, including those making the transition from armed forces to civilian life.

The area has a track record in military aerospace. Through the Moray Growth Deal, it is planned to construct a Moray Aerospace, Advanced Technology and Innovation Campus (MAATIC). The MAATIC will provide a leading role in generating innovative ideas and will be a catalyst for research and sharing of ideas and knowledge. Alongside this development, the Manufacturing Innovation Centre for Moray, will be co-located on the Lossiemouth site and provide support for existing and new manufacturing businesses.

The strengths of engineering and the strategy to diversify the benefits of the oil and gas industry around Scotland put Moray in a prime position as a great place to invest.

### 9.5.5 Environmental Wellbeing

#### 9.5.5.1 Biodiversity

Much of the uplands of Moray lie within the Cairngorms National Park, while on the coast there are nature reserves of national and local status.

Red deer are frequently encountered in herds in the higher and more remote parts of Moray. Its smaller cousin the Roe inhabits more low-lying areas. Foxes and badgers are abundant, whilst much rarer the wildcat and pine marten have a hold in Moray. Indigenous Red squirrels however still survive in reasonable numbers. But perhaps the most celebrated mammal is the bottle-nose dolphin, a colony of around 130 live in the Moray Firth.

Grey and common seals are relatively common offshore. Findhorn Bay is a staging post for many thousands of migrating wildfowl and waders in winter and during the summer is a reliable spot to observe Osprey.

### 9.5.5.2 Climate Change and Carbon Emissions

The effects of a changing climate are already beginning to be seen in Moray with increasingly frequent severe weather events requiring responses from the council, the emergency services and Community Planning Partners. Relevant impacts of climate change for Moray include food supply security, increased risk of droughts, increased risk of flooding and rising sea levels.

With respect to CO<sub>2</sub> emissions within the scope of influence of Local Authorities, as defined by the Department for Business, Energy & Industrial Strategy, per capita emissions of Moray are the highest of any Local Authority in Scotland. This is attributable in large part to Industry and commercial emissions per capita, 7.9t CO<sub>2</sub> per person, compared to the Scottish average of 4.9t CO<sub>2</sub> per person, and more specifically – the consumption of gas. These high relative emissions are assignable to Moray's whisky distilling sector, food producers and two MOD military facilities.



### 9.5.5.3 Living Environment

Inverness Airport is only 40 minutes away and Aberdeen Airport is approximately a 90-minute drive from Elgin. Moray has better air connections than most UK locations with 138 flights per week, including 35 flights to London airports and a daily connection into the international hub of Amsterdam. Every major UK city can be reached within a day.

There are over 40,000 households in Moray, with the average price of a home within the region sat slightly higher than the national average. The Council's Housing stock is an essential component of the local economy, particularly in its role of attracting, or retaining people in jobs, but also in the continuity of construction and maintenance work.

## 9.6 Regional and National Hydrogen Capacity

### 9.6.1 Scotland

Scotland has a key role to play in the development of a UK hydrogen economy, with the potential to produce industrial-scale quantities of hydrogen from offshore and onshore wind resources, wave and tidal power, as well as with Carbon Capture Usage and Storage – supported by a strong company base and valuable skills and assets in oil and gas, offshore wind, and energy systems. Economic analysis for the Scottish Government suggests that Scotland could deliver 21-126TWh of hydrogen per year by 2045, with up to 96TWh of hydrogen for export to Europe and the rest of the UK in the most ambitious scenario, delivering significant jobs and local economic benefits. The Scottish Government published a Hydrogen Policy Statement in December 2020, which set out their vision for the development of a hydrogen economy in Scotland and ambitions for renewable and low carbon hydrogen generation. A Hydrogen Action Plan will be published later this year, supported by a £100m programme of investment from 2021 to 2026.

### 9.6.2 United Kingdom

The UK is well positioned to be a world leader in low carbon hydrogen production and use and has made significant commitments and funding available to achieve this. Recent government press releases (August 2021) present a vision to kickstart the country as a world-leading hydrogen economy, with growing demand in recent years.

This in part has been driven by national commitments around decarbonisation across the economy in line with net-zero requirements. However, at the core of the UK's commitment around low carbon hydrogen production and use, is the recognition of the wider socio-economic benefits that this transition can bring. Growth of hydrogen markets could potentially create up to 100,000 new green jobs within the UK and generate £13billion of GVA through the national economy by 2050, directly supporting sustainable development and growth across regions. By 2030, hydrogen could play an important role in decarbonising polluting, energy-intensive industries like chemicals, oil refineries, power and heavy transport like shipping, HGVs and trains, by helping these sectors move away from fossil fuels. Low-carbon hydrogen provides opportunities for UK companies and workers across our industrial heartlands.



It is recognised that the UK can only realise these economic opportunities if action is taken to put in place the necessary support and environment to develop robust supply chains, upskill people and secure high-quality jobs, and lay the groundwork to unlock investment and export opportunities.

## 9.7 Case Studies

### 9.7.1 Tees Valley

The Tees Valley produces more than half of the UK's commercially available hydrogen and is home to a range of multi-national companies as well as other supply chain companies in the region. Hydrogen is used mainly in the conversion of heavy petroleum fractions and production of Ammonia, together with other uses across multiple industrial sectors.

The Tees Valley Hydrogen Innovation Project (TVHIP) aims to support SMEs in the Tees Valley to develop new business networks, products, and processes through the development of a hydrogen low carbon economy.

Financially supported through the European Regional Development Fund (ERDF), the project offers a minimum of 12 hours of fully funded support to eligible SMEs\*.

### 9.7.2 Northern Gas Networks – Winlaton, Gateshead

The HyDeploy project is blending hydrogen with natural gas on a public gas network in Winlaton, Gateshead operated by Northern Gas Networks.

Heating in the UK is currently responsible for a third of carbon emissions. Because hydrogen produces no carbon at the point of use, it is a viable alternative for heating homes and businesses to achieve the Government's target of Net Zero carbon emissions by 2050.

In a ten-month long pilot, HyDeploy is now blending up to 20% of hydrogen (by volume) for 668 homes and a primary school in Winlaton.

Customers are continuing to use their gas supply and appliances as normal, without any changes needed to gas appliances or pipework as current gas appliances are designed to operate with a blend of up to 23% hydrogen.



Most participants reported little disruption both prior to and during the trial and valued the feeling of contributing to climate action without needing conscious effort. Some participants viewed the trial and their (and Keele University's) involvement in an extremely positive light, going beyond just acceptance of the trial to expressing excitement. Such positive reactions may be linked to pride in a place to which they feel attached, or the 'halo' effect of making a positive contribution as an individual (or organisation).

# 7,000

people employed in rural Scottish  
area within Scotch whisky industry

### 9.7.3 Orkney Island: BIG HIT Project

BIG HIT (Building Innovative Green Hydrogen Systems in Isolated Territories) is a six-year, Orkney based demonstration project which aims to create an integrated low carbon and localised energy system establishing a replicable model of hydrogen production, storage, distribution and use for heat, power and transport. The learning from BIG HIT about the benefits of using hydrogen with renewable energy sources in the Orkney Islands will support the much wider replication and further deployments of renewable energy with fuel cell & hydrogen technologies in isolated or constrained territories.

### 9.7.4 The Green Distilleries Competition

Eleven distilleries across Scotland and a further six in England will be able to kick-start green innovations thanks to the government backing, helping them harness energy sources such as low-carbon hydrogen, biomass and repurposed waste to power their operations. The successful distilleries will receive between £44,000 and £75,000 in the first phase of funding (£10mil total), helping them boost decarbonisation research and development, with schemes including the use of hydrogen and biofuel boilers and geothermal energy in their production processes. The funding will help prevent pollution equivalent to taking 200,000 cars off the road.

In 2019, the UK distilleries industry grew by 20%, highlighting the opportunity for the sector to be at the heart of the UK's green and resilient recovery from coronavirus. The Scotch whisky industry supports 40,000 jobs across the UK, with more than 10,000 people directly employed in Scotland. With 7,000 of these jobs in rural Scottish areas, this funding will drive forward support for net-zero innovation in some geographically remote parts of the UK, creating more jobs and skills and providing opportunities for distilleries to develop their fuel transportation and storage technologies.

# 10. Hydrogen Strategy for Moray

Moray is a natural location to establish a hydrogen economy and develop wider green technologies to support Scotland's renewable energy supply chain.





## 10.1 Introduction

There are significant opportunities, set out in this Hydrogen Strategy, to generate local community benefits in relation to social, economic, and environmental wellbeing. These opportunities align with the Council's net-zero targets with recognised benefits associated with the green transition.

The Hydrogen Strategy action plan identifies the short-, medium-, and long-term actions required to develop a hydrogen economy for Moray and to generate local community benefits.

The stakeholder analysis has shown that there is a significant interest in using hydrogen as a fuel in the Moray area and the demand analysis has shown the potential growth, given the right economic conditions.

## 10.2 Scope Summary

### 10.2.1 Government Policies

The Scottish Government Hydrogen Policy Statement, published December 2020, sets out Scottish Government support for the strategic growth of a strong hydrogen economy in Scotland. The Minister for Energy, Connectivity, and the Islands provides the following vision in the ministerial forward:

“Our vision is for Scotland to become a leading Hydrogen Nation in the production of reliable, competitive, sustainable hydrogen and secure Scotland's future as a centre for international excellence as we establish the innovation skills and supply chain that will underpin our energy transition. Scotland's unique selling points, are its natural resources, infrastructure and skilled energy workforce which enable us to become the producer of lowest cost hydrogen in Europe by 2045.”



The Scottish Government Draft Hydrogen Action Plan, published November 2021, sets out the actions for the next five years to support the development of a hydrogen economy. The Cabinet Secretary for Net Zero, Energy and Transport includes the following statement as part of the ministerial forward:



Hydrogen has a role to play across Scotland in our islands and rural communities, cities and industrial clusters, and strategies for its production and application are expected to vary across these geographic regions. We are committed to realising the benefits of hydrogen to our regions and local communities and so will support regional hubs of hydrogen activity across Scotland, recognising the differing resources, strengths and focuses of each location.

The UK and Scottish Governments are committed to realising the benefits of hydrogen to our regions and local communities and will support regional hubs of hydrogen activity. Government funding and resources are available to support hydrogen projects and technologies within Moray.

### 10.2.2 Opportunities for Moray

There is an opportunity for Moray Council to develop a Hydrogen Economy and retain significant benefits within Moray. The prevalence of off-shore and on-shore renewable energy production and the potential for this to be increased offers Moray the opportunity to produce green hydrogen. The development of Hydrogen Economy within Moray will bring many benefits to the region including inward investment, creation of new opportunities and jobs, retention and development of young persons in Moray. Further work is required to determine the GVA; however, it is expected to be significant.



### 10.2.3 Hydrogen Demand in Moray

There is a clear demand for Hydrogen in Moray. The largest potential users for hydrogen are the distilleries and domestic properties in the medium to long term, however in the short term expected demand is from road freight trials including HGVs, buses, refuse vehicles and other council vehicles and grid blending make up the majority of the total projections.



### 10.2.4 Hydrogen Corridor through Moray

There is an opportunity to create a Hydrogen Corridor through Moray by considering a hydrogen refuelling stations along the route of the A96. Keith (near Blackhillock) offers a location approximately halfway between Aberdeen and Inverness. It is also important to consider the transport movements from A95 towards the Central Belt, primarily from the whiskey industry, and a fuelling zone along this corridor. Engagement with The Highland Council, Aberdeenshire Council and Aberdeen City Council will be required to review and agree the best way for a hydrogen corridor to be developed.

### 10.2.5 Key partners and Funding Opportunities

Key Partners for Moray will be HIE; Scottish Enterprise; Renewable Energy Developers (e.g. Ocean Winds); Scottish Gas Networks; Moray Chamber; the wider whisky industry (i.e. distilleries, transport logistics, raw material suppliers etc); and, other industries and public sector bodies with larger HGV type vehicles.

A selection of the funds that may be applicable for supporting the introduction of a hydrogen economy in Moray are provided in the table on the right:

Fund	Value	Notes
Just Transition Fund	£500m	For North East and Moray
Energy Transition Fund	£62m	
Energy Technologies Fund (Hydrogen)	£100m	
Scottish Zero Emission Bus Challenge Fund	£50m	
Low-Carbon Manufacturing Challenge Fund	£50m	
Green Growth Accelerators Programme (local authorities)	£200m	Public and private investment
Green Jobs Fund (Enterprise Agencies)	£100m	

**Table 10.1: Available Funds to support a Hydrogen Economy**



### 10.2.6 Key Stakeholders

Most stakeholders engaged as part of this study were very positive towards Hydrogen. It was felt that Hydrogen (in particular Green Hydrogen) can form part of the solution to achieve net-zero and the time to act is now. A significant number of stakeholders would like to be involved in the next steps and to assist Moray Council in developing a Hydrogen Economy for the benefit of Moray.

There will be a number of challenges to take this forward. A collaborative approach is required to take forward and maximise this opportunity for Moray.

### 10.2.7 Role of Hydrogen in Moray's future

The work carried out to date provides confidence that Hydrogen can play a significant role in Moray's transition to a low carbon future and through the development of a hydrogen economy within Moray, allow for creation of new jobs and opportunities.

As part of short-term actions, consideration needs to be given to the skills and training that will be required to support the development of the hydrogen economy. As well as increasing knowledge and promoting the industry within schools, engagement with further education establishments is required to create education programmes to develop the skills and knowledge required locally to support the Hydrogen Economy.



### 10.2.8 Key Interventions

Initial interventions (pilots) have been identified at the following locations for the short-term:

- Lossiemouth
- Aberlour
- Buckie Harbour
- Elgin

Depending on the success of the pilot project(s), these interventions may be expanded to suit medium- and long-term demand.

Further interventions have been proposed at the following locations for the medium- and long-term:

- East of Portsoy (Caledonia Off-Shore Windfarm)
- Blackhillock

### 10.2.9 Proposed Locations and Infrastructure Requirements

The order of magnitude costs for the proposed electrolyzers and hydrogen infrastructure are shown in Table 10.2. Further work is required to determine the exact site locations and to optimise the size and scope of the facilities required.

Electrolyser Size MWe	Cost Estimate (Electrolyser and Storage)	Notes
2.3	£3.7m	Pilot project, suitable for Lossiemouth, Aberlour, Buckie, and Elgin.
65	£82m	
130	£134m	
300	£339m	Po tential long term hydrogen production in Moray.

Table 10.2: Hydrogen infrastructure costs

Additional Costs:

- A 1000kg / day Hydrogen Refuelling Station will cost approximately £1.6m per station.
- Tube trailer loading facilities for the distribution of hydrogen, including tube trailers will cost approximately £3.6m.

A 2.3MW electrolyser, producing 1000kg / day of hydrogen, complete with a Hydrogen Refuelling Station would cost approximately £3.7m + £1.6M = £5.3m excluding land costs. This size is suitable for a pilot project to initiate the hydrogen economy in Moray.

# Moray Hydrogen Strategy

**Key:**

- Moray events
- National Scottish events

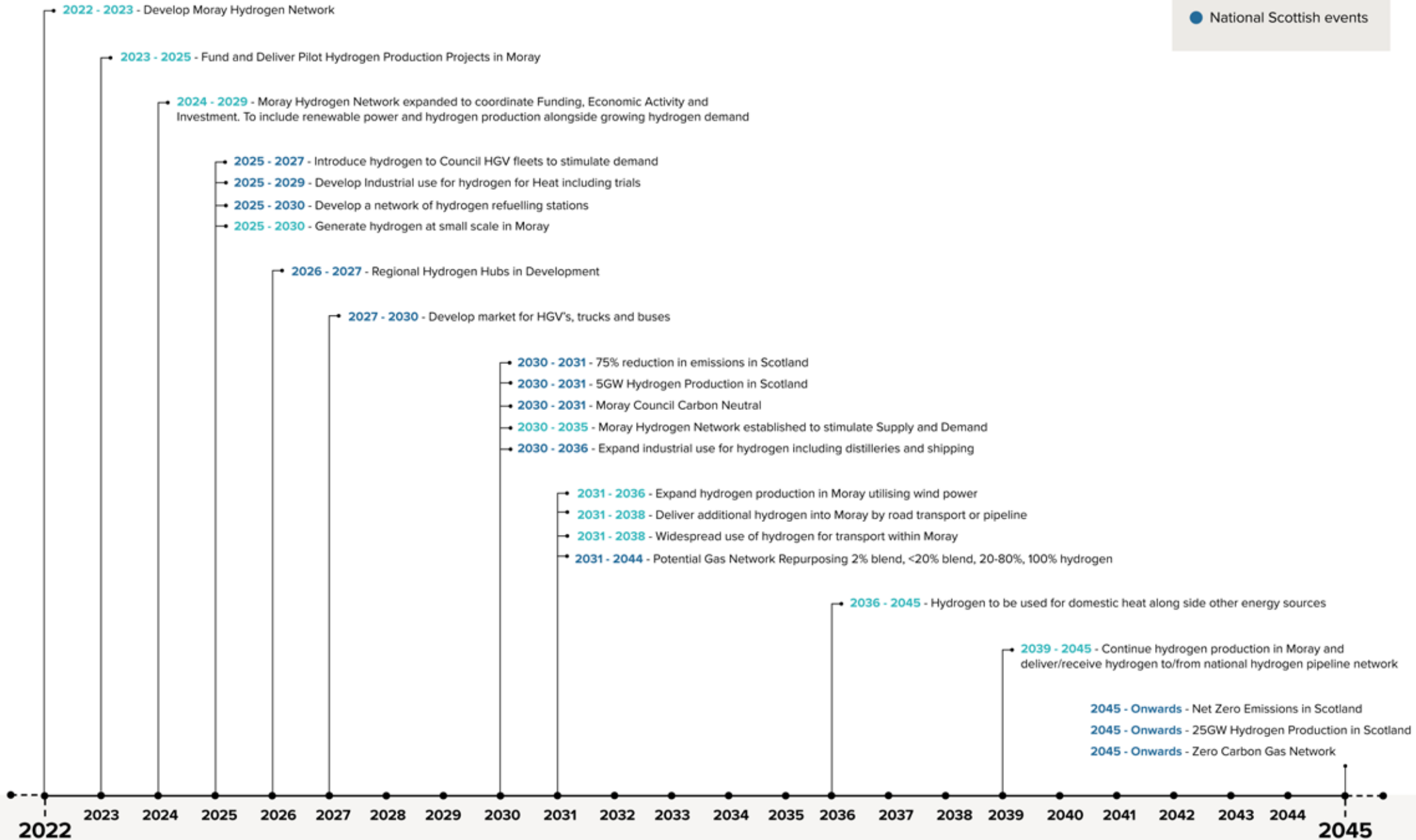

## 10.4 Short Term Actions

### 10.4.1 Immediate Actions

# 1.

Consider how Moray Council wish to take forward the development of a Hydrogen Economy within Moray – whether as a supporting facilitator of development by others or leading the development. The latter could be through an arm’s length company or directly as the Council. This would allow Moray Council to have more control as the economy is developed and allow the generated wealth to be retained and re-invested in Moray in line with key aims/objectives of Moray Council.



# 2.

It may be that in the short-term and to maintain momentum, it is led by Moray Council whilst the longer-term solution is worked through and developed.

Things to consider include:

- Expanding the current team to coordinate and maximise funding opportunities, economic activity and investment.
- Development of a robust Organisation structure
- Website and promotion of Hydrogen.

# 3.

Develop enhanced relationships with key partners and adjacent Councils. Establish a hydrogen steering group encompassing organisations such as HIE, Moray Chamber, UHI Moray, key industries (potential suppliers and users), Hydrogen experts and renewable energy developers as well as Moray Council.

The role of the steering group would be to take ownership to drive forwards the development of a hydrogen economy bringing together key stakeholders and industry partners. Through working groups and bringing in relevant members of the hydrogen stakeholder network, the steering group needs to get buy-in and commitment from industry (suppliers and users) to work together to develop a hydrogen economy in Moray for the benefit of Moray. The hydrogen strategy will be reviewed every three years as a minimum and revised as required.

The steering group needs to be a focused group with the empowerment, desire and ability to progress actions and maximise the hydrogen opportunities that are available for Moray.

# 4.

Establish a hydrogen stakeholder network in Moray. This needs to include community and education groups as well as industry. From the stakeholder engagement carried out as part of this study, there is a lot of enthusiasm for a hydrogen economy within Moray and a desire from many groups (distilleries, transport, large and small businesses, public services, and community groups) to be part of this as it develops.

It is important that community groups are involved and that community wealth building, social value and removing fuel poverty are front and centre of the hydrogen economy. This means keeping as much of the economy in Moray for investment and jobs. It also needs to be recognised that in the short and medium term, energy will be expensive.



# 5.

Investigate funding opportunities (for example, the Just Transition Fund) and apply for initial funding to fund a dedicated team to develop the Hydrogen Economy opportunities, allow further development of pilot project opportunities (feasibility, design development etc.), develop one (or more) pilot projects (installation) and then review and assess the success of the pilots and identify/plan the hubs that will be required to meet the medium- and long-term demands.

# 6.

Promotion and knowledge development of Hydrogen within schools. Engagement with further education establishments is required to create education programmes to develop the skills and knowledge required locally to support the Hydrogen Economy.

# 7.

Set up, fund and initiate / deliver at least 1 pilot project to generate interest and demand. This will also stimulate the economy, test the infrastructure, provide opportunities for learning and increased confidence and surety on the way forward for Moray.



### 10.4.2 Pilot Projects

Whilst we have assessed six potential hydrogen hub locations as part of this study, not all are suited to be taken forward as pilot projects.

From the potential locations assessed as part of this study, we have identified four potential pilot projects. The table on the right summarises each of the projects and their benefits and constraints. We provide further rationale behind each of the potential pilot projects within Section 6.2 of the report.

The pilot project(s) taken forward will take of the order of three years to be implemented. The current lead time for an electrolyser is approximately 18 months. Depending on the location of the pilot, time will be required for approvals (Planning, SEPA) as well as construction of the associated infrastructure.

It should be noted that this is very much high level and further assessment of each is required to allow a determination on the project or projects that offer most value to Moray in the short-term to be taken forward as pilot projects.

Project/Hub Name	Benefits	Constraints
Lossiemouth	<ul style="list-style-type: none"> <li>• Close to Elgin</li> <li>• Access to MOD/RAF solar power at potentially a reduced cost</li> <li>• MOD/RAF are a potential partner</li> <li>• Close to future solar farms</li> <li>• Access to grid power</li> <li>• Option to extend within MoD land.</li> </ul>	<ul style="list-style-type: none"> <li>• Solar power is insufficient for hydrogen at scale</li> <li>• Grid power may be high cost</li> <li>• May not be suitable for significant expansion due to power availability and location</li> <li>• Located 6 miles from A 96</li> <li>• Limited HGVs in vicinity compared with other locations.</li> <li>• May need to supplement initial supplies with import.</li> </ul>
Aberlour Hub	<ul style="list-style-type: none"> <li>• Access to onshore wind power</li> <li>• Close to local transport fleets</li> <li>• Could drive demand from nearby industrial users (i.e. distilleries)</li> <li>• Can be expanded to meet growing industrial demand</li> <li>• Good location to distribute hydrogen to transport refuelling sites throughout Moray</li> <li>• Distilleries and transport logistics companies keen to support.</li> </ul>	<ul style="list-style-type: none"> <li>• Benefits depend on wind power supply agreements</li> <li>• Potential land issues</li> </ul>
Buckie Harbour	<ul style="list-style-type: none"> <li>• Social benefits for investment in Buckie Harbour</li> <li>• Grid power available, possible access to offshore wind power</li> <li>• Can drive demand from offshore crew transport vessels and local transport fleets</li> <li>• Located near potential industrial users (maltings)</li> <li>• Could form part of the Buckie Harbour Masterplan development.</li> </ul>	<ul style="list-style-type: none"> <li>• Grid power may be high cost</li> <li>• Distance from road transport and other industrial users in Moray</li> </ul>
Elgin	<ul style="list-style-type: none"> <li>• Close to council fleets and local transport</li> <li>• Excellent location to distribute hydrogen to future transport refuelling stations throughout Moray</li> <li>• Set up could be “rolled out” in locations with similar initial hydrogen demand - e.g. Forres</li> <li>• Could tie-in with HGV parking</li> </ul>	<ul style="list-style-type: none"> <li>• Grid power may be high cost</li> <li>• May need to supplement initial supplies with import.</li> </ul>

Table 10.4.2: Hydrogen Projects



### 10.4.3 Short Term – Beyond pilot projects

The intent in the short term is to generate hydrogen at a small scale in Moray. Once the pilot project(s) is up and running, there should be ongoing assessment of the pilot to determine whether the pilot location is appropriate for the medium and long term.

In the short-term up to 2030, the organisational vehicle that will drive forward the Hydrogen Economy within Moray needs to be set up and empowered to plan for the medium term and begin implementing actions so that by 2030, Moray is in the right place to expand the supply to meet the increasing demand.

#### Aims would include:

- Identify Funding and Investment to drive the Hydrogen Economy
- Develop and expand demand
- Review and assess the pilot project(s)
- Identify and confirm hydrogen production and refuelling locations
- Commence procurement of hydrogen production facilities
- Consider supporting community renewable projects that could be subsequently developed as small-scale hydrogen hubs in the future as costs reduce.



Project/Hub Name	Benefits	Constraints
East of Portsoy (Aberdeenshire) – Caledonia Wind Farm	<ul style="list-style-type: none"> <li>• Access to low-cost offshore wind power (from 2032)</li> <li>• Significant energy available (300MW)</li> </ul>	<ul style="list-style-type: none"> <li>• Distance from road transport and industrial users in Moray</li> <li>• Location still to be confirmed but is likely to be outside Moray and therefore potentially outside scope of this study</li> </ul>
Blackhillock (Keith)	<ul style="list-style-type: none"> <li>• Access to low cost onshore and offshore wind power</li> <li>• Access to grid power</li> <li>• Close to local transport fleets</li> <li>• Could drive demand from nearby industrial users</li> <li>• Can be expanded to meet growing industrial demand</li> <li>• Good location to distribute hydrogen to transport refuelling sites throughout Moray</li> </ul>	<ul style="list-style-type: none"> <li>• Benefits depend on wind power supply agreements</li> <li>• Potential land issues</li> </ul>

Table 10.4.2: Hydrogen Projects

### 10.5 Medium-Term (2030 to 2040) Aims

Brief description/summary of medium-term demand and opportunities.

In the medium-term the key aim will be to grow the hydrogen supply in Moray by expanding the installed electrolysers, distributing hydrogen to a network of hydrogen refuelling stations and industrial users, in a hub system use road-based tube trailers. The significant increase in demand occurs during the medium term and there is the opportunity to utilise offshore wind power (e.g. Caledonia Wind Farm) to expand hydrogen production based on offshore wind power.

From the potential locations assessed as part of this study, we have identified two hub projects that could be developed in the medium term. This would be alongside the expansion of one or more of the pilot projects. The table below summarises each of the projects and their benefits and constraints. We provide further rationale behind each of the potential pilot projects within Section 6.2 of the report. By early in medium term, there should be an aim to have developed a network of hydrogen refuelling stations. This will allow new HGVs and large-vehicle fleets to be hydrogen fuelled. For industry, the supply will need to be in place and proven to allow the financial commitment of a complete switch to hydrogen vehicles to occur.



Throughout much of the medium term, there should be widespread use of hydrogen for large-vehicle transport within Moray.

In addition to vehicle demand, there will be a need to develop industrial use for hydrogen for heating. As with the pilot projects and their immediate focus on vehicles, trials will be required to test and prove the technology. Depending on the further opportunities for renewable energy generation within Moray, there would be the option to supplement local supplies by bringing in hydrogen from Inverness or Aberdeen/ Aberdeenshire. This should be looked at as part of the regular re-evaluation of the economic case for hydrogen.



In addition, it is the current SGN policy that the SGN gas network will be repurposed during this timeframe to provide heating for homes using hydrogen with delivery by pipeline. Therefore, towards the end of 2030s, there is a strong likelihood for hydrogen to be used for domestic heat alongside other energy sources.

## 10.6 Long-Term (2040 onwards) Aims

The long-term will be primarily about the continued hydrogen production in Moray and deliver/receive hydrogen to/from national hydrogen pipeline network. The hydrogen economy will be fully developed and net zero achieved through this and other renewable energy sources.

In this period, there should be consolidation of the hydrogen production facilities within Moray and identification of opportunities for the further expansion and growth of the hydrogen economy in Moray.

From 2040 onwards as technologies improve and bring down costs, there is the potential for the development of smaller scale community projects (particularly for areas that are “off-grid”). As well as allowing energy to be created and used at source, it creates increased resilience within the energy network and offers the opportunity for communities to be self-sustaining.



Opening opportunities  
with connected thinking.

[mottmac.com](https://mottmac.com)

